

Despatch

INSTRUCTION MANUAL FOR LEA SERIES CHAMBERS

C-79
054925
11/86

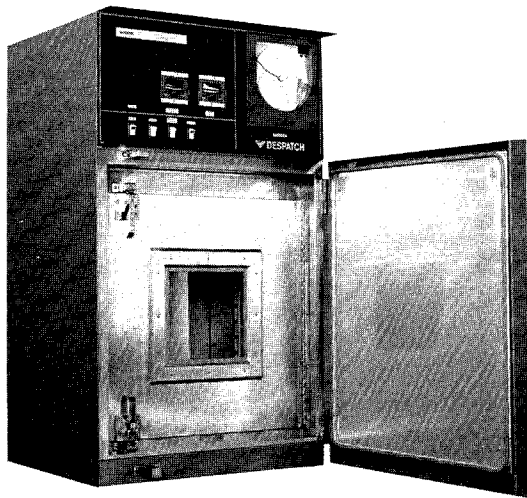

LEA 1-69

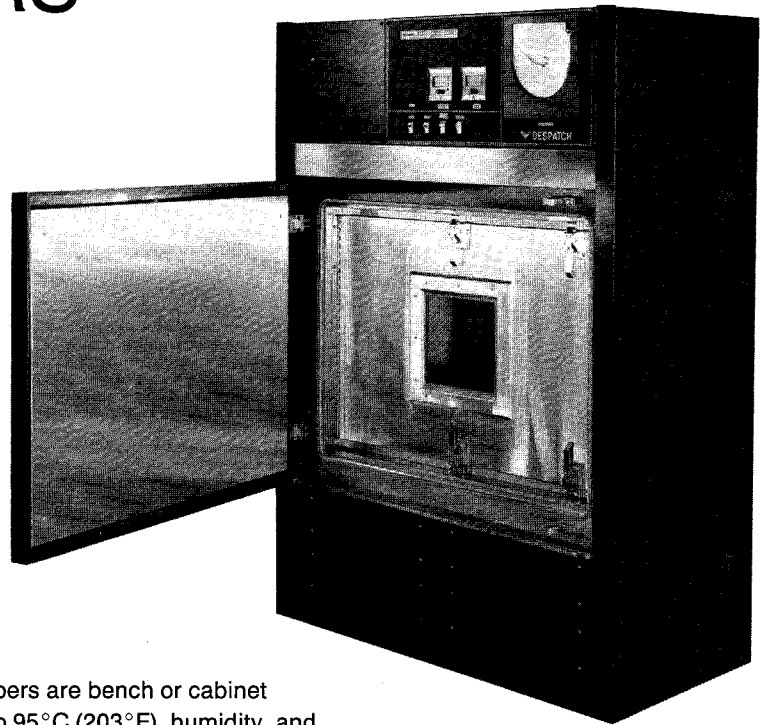

LEA 2-11

Despatch LEA series chambers are bench or cabinet models with temperatures to 95°C (203°F), humidity, and forced convected airflow.

MODEL	VOLTS	AIR HEATER WATTS	HUMIDITY HEATER WATTS	AMPS	HZ	PHASE
LEA 1-69	240	2,400	2,000	22.2	60	1
	208	1,800	1,500	19.4	60	1
LEA 2-11	240	4,800	3,000	37.4	60	1
	208	3,600	2,250	31.6	60	1
LEA 2-21 V/H	240	4,800	3,000	38.0/41.0	60	1
	208	3,600	2,250	33.0/36.0	60	1

INDEX

	PAGE
Specifications	cover
Index	2
Introduction	3
Unpacking, Inspection and Packing List	3
Installation	3
Pre Start-up	4
Initial Start-up	4
General Information on Operation	4
1. Glossary of Terms	4
2. Method of Cooling	4
3. Mounting Methods for Internal Fixturing	4
4. Materials for Construction of Fixtures	5
5. Electrical Insulating Material	5
6. Load Density	5
7. Sealing Cable Entrance Ports	5
8. Condensation	5
9. Corrosion	6
Chamber Operation	7
Operating Range Charts	7
Temperature Control	8
Trouble Shooting, Temperature Control	9
Relative Humidity Control	10
Trouble Shooting, Humidity Control	11
Standard Hi-Limit Control	12
Optional Hi-Limit and Humidity Recorder	12
Recorder Adjustments & Calibration	12
Process Timer	14
Maintenance	15
Trouble Shooting, Chamber	17
Timer Schematic	19
Electrical Schematic	20
Hi-Limit Schematic	22
Warranty	back

INTRODUCTION

The Despatch LEA series are precise high quality, temperature and humidity chambers featuring a vertical or horizontal airflow system for rapid, uniform distribution of heat and humidity throughout the chamber.

To obtain optimal results from your Despatch chamber, thoroughly familiarize yourself with this manual and the various procedures outlined.

WARNING: Failure to heed these restrictions can result in property damage, serious bodily injury or death.

THE USER(S) OF THIS EQUIPMENT MUST COMPLY WITH OPERATING PROCEDURES AND TRAINING OF OPERATING PERSONNEL AS STATED IN THE OCCUPATIONAL SAFETY AND HEALTH ACT (OSHA) OF 1970, SECTION 5, AND THE NATIONAL FIRE PROTECTION ASSOCIATION (NFPA) 86A OF 1973 (ARTICLE 100, SECTION 2d, AND APPENDIX 1).

DO NOT use chamber in wet, corrosive or explosive atmosphere.

DO NOT attempt any service on this equipment without first disconnecting the electrical power to this unit. Disconnect main power switch or power cord.

DO NOT exceed the maximum operating temperature, 95°C (203°F).

DO NOT use any flammable solvent or other flammable materials or enclosed containers in the work chamber.

FOR supply connections on LEA 1-69, use 10 AWG or larger wires suitable for at least 75°C (167°F).

FOR supply connections on LEA 2-11 & 21 use 8 AWG or larger wires suitable for at least 90°C (194°F)

A cloud of steam may be released when the inner door is opened, and steam burns.

UNPACKING, INSPECTION AND PACKING LIST

Remove all packing materials and inspect the chamber for damage. If damaged due to shipment, contact the shipper immediately. If chamber parts are damaged, or if parts are missing, contact Despatch Customer Service at 800/328-5476 (in MN 800/462-5396).

You should have in this box:

One chamber

*Two shelves

*One package containing four rubber feet

One instruction manual

Warranty card

Any optional accessories ordered will be included.

*LEA 1-69 only

INSTALLATION

*Remove the adhesive backing sheet from the rubber feet and attach the rubber feet to the bottom corners of the chamber.

*Place the chamber on a bench top or optional cabinet base. The chamber must have a minimum of 2" clearance on all three sides to provide proper ventilation.

Make sure the chamber is level and plumb. This will assure proper heat distribution and operation of all mechanical components.

Check the chamber power requirements for amperage and voltage on the cover of this manual.

Connect the electric supply directly to the chamber to terminals located behind control panel (see electrical schematic in back of manual) with all required grounding and safety equipment, in compliance with applicable codes, ordinances and accepted safe practices. For supply connections, use 10 AWG or larger wire suitable for at least 75°C (167°F).

A note on line voltage: Line voltages may vary according to your geographical location. If line voltage is significantly lower than oven voltage rating, heat up times will be extended, and motor

may overheat. If line voltage varies more than $\pm 10\%$ from the chamber voltage rating, temperature and humidity controls will operate erratically.

Chambers designed for 240 volts (see nameplate on oven) will operate satisfactorily on a minimum of 208 volts by changing the control transformer input leads, but with a reduction in heater power and heat-up time. If your power characteristics are lower, contact Despatch Industries, Inc.

Recommended Water Connection

1. The water inlet to the humidification system (marked humidity generator water inlet) requires demineralized or deionized water. The recommended flow rate is 1 gallon per hour. The recommended pressure is 20-40 psi.

To install optional demineralizer cartridges to the back of chamber see section on demineralized cartridge.

Pipe the drain (marked water drain) from the chamber to an open drain.

2. Cooldown times are dependent on cooling water flow rate. Recommended cooling is 50 gallons per hour.

Optional flowmeter is recommended if water cooling is to be used. Connect a clean water supply to the flowmeter and connect flowmeter to the chamber connection (marked cooling water inlet). The brass needle valve on the face of the water flowmeter can be used for adjusting the water flow or shutting off the water flow. The other pipe on the rear of the oven (marked cooling water drain) should be piped to an open drain. Never allow drain to be plugged as a hot oven will generate a small amount of pressure when the water is first turned on.

WARNING: Steam burns!

Cooling water for the cooling coil need not be deionized or distilled. However, mineral deposits will degrade the heat transfer characteristics of the cooling coil and can become plugged over time.

PRE START-UP

1. Know the System

Read this manual carefully. Make use of its instructions and explanations. The "Know How" of safe, continuous, satisfactory, trouble free operation depends primarily on the degree of your understanding of the system and of your willingness to keep all parts in proper operating condition.

2. Check Line Voltage

This must correspond to nameplate requirements of motors and controls. An incorrect voltage can result in serious damage.

3. Fresh Air and Exhaust Openings

Avoid restrictions in and around the fresh air and exhaust openings. Under no condition permit them to become so filled with dirt that they appreciably reduce the air quantity.

INITIAL START-UP

1. Close steam generator drain valve. **Note:** Humidity system will not operate without water in the steam generator. Therefore the humidity system will not operate for about 15 minutes while the steam generator fills with water.

2. Turn Power Switch On

3. Hi-Limit Adjustment

NOTE: Never operate chamber at a temperature in excess of the maximum operating temperature which is 95°C (203°F).

The hi-limit controller can be used for the protection of the equipment or the product against excessive temperatures when set properly. See section on hi-limit instrument for more information.

NOTE: All chambers are tested at the factory; however, shipping may cause damage or deviation. Therefore, before oven is put into regular service, the following items should be inspected and adjusted if necessary: hi-limit and control instrument calibration, doors, hinges, latches and other miscellaneous parts.

GENERAL INFORMATION ON OPERATION

1. GLOSSARY OF TERMS

A. Relative Humidity (RH)

Amount of water vapor present in a given volume of air expressed as a percentage of maximum amount possible in that volume at a given temperature.

Example: A relative humidity of 75% means that air contains 75% of maximum moisture possible at that temperature.

B. Dew Point

Temperature at which condensation begins at a given humidity, volume and pressure.

NOTE: Dew point is always lower than dry bulb temperature, except when air is saturated. At saturation, dew point, wet bulb and dry bulb temperature coincide.

2. METHOD OF COOLING

A. Room ambient air is propelled through the outside of the cooling heat exchanger. The recirculation fan circulates air past the inside of the heat exchanger where it is cooled and dew point is reduced.

B. A water cooling coil can be used to assist the air heat exchanger if additional cooling or a reduced dew point is required.

3. MOUNTING METHODS FOR INTERNAL FIXTURING

Many applications for temperature/humidity chambers involve installation of internal fixtures to support components being tested and necessitate additional lead-in ports to provide entrance for wires, cables, thermocouples, etc.

NOTE: DO NOT INDISCRIMINATELY PERFORATE THE INNER CHAMBER WALLS AS THIS WILL VOID WARRANTY.

A machine screw or sheet metal screw DOES NOT CONSTITUTE A VAPOR-TIGHT SEAL. When simulating high temperature, high humidity condition, water vapor will seep through screw threads into insulation, saturate insulation and water drippage will start at bottom of outer housing.

Fixtures must be designed to facilitate their removal during regular maintenance and cleaning of the chamber. Failure to design fixtures properly may cause unnecessary delay when equipment is shut down for cleaning or maintenance.

NOTE: ANY FIXTURING OR REMOVABLE PARTS OF CHAMBER SHOWING SIGNS OF PERMANENT CORROSION SHOULD BE REPLACED.

4. MATERIALS FOR CONSTRUCTION OF FIXTURES

A. Type 316 stainless steel is recommended for all fixtures. Any additions to chamber must be of equal or better grade. This applies not only to ports and fixtures, but to screws and related hardware to construct and mount them.

B. Do not use any iron or mild steel materials in cabinet interior. This applies to any type of cold or hot rolled steel, either painted or plated. Painted or plated surfaces soon deteriorate under high temperature and humidity conditions. Two reasons to avoid use of these materials are:

1. Corroding steel will "seed" stainless steel with particles of rust. These particles will cause rapid deterioration in any stainless steel it contacts. Once such chemical corrosion starts, it can only be stopped by electropolishing or passivation.

2. This "seeding process" will cause similar corrosion on test loads; effects of this corrosion will be impossible to separate from temperature and humidity effects, and may void test results.

C. After fabrication of stainless steel fixtures, it is essential that they be passivated before being placed in chamber. This is the only effective method in assuring that fixtures are free of contaminants. Particles of tool steel remain embedded in stainless steel after drilling, punching and other fabrication processes. These particles must be removed, or they will begin to corrode rapidly in high temperature and humidity conditions. If such corrosion is allowed to continue, surrounding stainless steel will also corrode.

D. Supplementary items such as plugs, sockets, wiring and printed circuit boards must be of a quality to last longer than components under test. All supplementary equipment and fixtures are subjected to same conditions as test load, and should be chosen with care.

E. When components to be tested are ferrous metals and are expected to corrode, or purpose of test is to "force" corrosion, provision should be made to provide drip pans to retain any residue produced. This prevents residue from contacting inner chamber areas and/or control sensors.

F. ANY PART OF FIXTURING OR ANY REMOVABLE SECTIONS OF CHAMBER INTERIOR SHOWING SIGNS OF PERMANENT CORROSION THAT CANNOT BE ELIMINATED BY PROPER CLEANING SHOULD BE IMMEDIATELY REMOVED AND REPLACED.

5. ELECTRICAL INSULATING MATERIAL

When components under test have electrical voltages applied to them, all insulating materials must be suitable for high temperature/high humidity conditions. Even very small leakage currents traveling through cabinet or fixture will produce rapid electrolytic corrosion just to fixture. Glazed porcelain or glass insulators, treated with Dow Corning 200 Solicon fluid, appear to be some of the best materials presently available.

6. LOADING DENSITY

Personnel often overload chambers, seeking to make most use of test equipment. While some conditions will permit indiscriminate loading, most will not. If wide

tolerances are permissible, maximum loading of work chamber is permissible. It should be kept in mind, however, that fewer components in work chamber generally means closer tolerances. It is recommended that no component be loaded closer than three inches to an internal surface. If extremely close tolerances in testing are required, it is recommended that a dummy load simulating the component in size and mass be placed in chamber and a test program run.

If it is difficult to produce desired accuracy, load may be too large for chamber.

Live loads in the work chamber will affect the units ability to control at a given temperature and humidity.

7. SEALING CABLE ENTRANCE PORTS

All entrance ports for large diameter cables or wire bundles must be sealed before chamber is placed in operation. This precaution is often neglected and can cause annoying problems. Condensation will continually run down the cable and drip on floor or external instruments. Excessive water usage will occur because of these openings to atmosphere. If opening is very large, internal control stability can be affected. Silicone RTV is a suitable filler for these points provided a more sophisticated sealing method is not available.

8. CONDENSATION

All chambers are capable of operating at high temperatures and up to 95% relative humidity without condensation forming on workload. Some condensation may form on walls of work chamber; these are areas of heat loss and are slightly cooler than rest of chamber. Such condensation is normal and should not be considered as a malfunction of chamber. Severe condensation normally forms on components when loaded into cabinet that is operating at high temperature and humidity. Any material at ambient temperature may be below dew point and condensation may form on surface and continue to form until material temperature exceeds the dew point.

TO AVOID CONDENSATION ON LOAD:

- A. Test load and chamber at ambient temperature.
 1. Turn humidity and air heater switches OFF.
 2. Load chamber, close doors.
 3. Turn power and air heater switches ON.
 4. Set temperature control for desired temperature and allow chamber to stabilize.
 5. Turn humidity heater switch ON.

6. In small steps, adjust humidity control for desired setting. If humidity is raised too quickly, dew point may rise faster than temperature of test load, creating condensation on load surface. This effect will be most noticeable on high mass loads.

B. Test load at ambient, chamber at high temperature and humidity.

1. Turn humidity and air switches OFF, allowing blower to continue operating.
2. Open outer and inner doors.

WARNING: A cloud of steam may be released when the inner door is opened, and STEAM BURNS!

3. Allow chamber to cool approximately 5 minutes.
4. Chamber can be loaded and operated normally as outlined in "A".

C. Unloading of the work chamber.

1. To avoid condensation on parts, turn off humidity heater, turn on cooling, reduce temperature set point and wait for chamber to cool. Parts can also be removed hot. (See warning above).

NOTE: FAILURE TO FOLLOW THESE INSTRUCTIONS MAY CAUSE DAMAGE TO UNIT. SUCH DAMAGE WILL NOT BE COVERED BY WARRANTY.

9. CORROSION

Corrosion is undoubtedly the most widespread and probably the most costly water caused problem. Corrosion of ferrous and non-ferrous metals is basically an electrolytic action requiring presence of water or water vapor.

This chamber will be operating under ideal conditions for accelerating corrosion (i.e., water, water vapor, high temperature plus an infinite variety of contaminants introduced by products under test). Therefore, it is reasonable to assume that the cost of maintaining its operation could be greater than the cost of maintaining non-humidity chambers.

Your chamber is constructed of high quality materials suitable for this type of application. It is, however, designed and manufactured to fulfill the widest variety of normal applications. Unusually corrosive applications may have special engineering problems and cannot be satisfactorily performed by a standard chamber. Frequently, only after a chamber is partially damaged does one become aware of this unusual application.

THE MOST COMMON CAUSES OF CORROSIVE ATTACK ARE AS FOLLOWS:

A. FAILURE TO PROVIDE A CLEAN WATER SUPPLY.

Dissolved solids are gases in a water supply serving the chamber are injurious to stainless steel alloys.

High chloride content is particularly damaging.

B. INTRODUCTION OF THE HALOGEN SALTS (CHLORINE, FLUORINE, BROMINE, IODINE) EITHER BY THE WATER SUPPLY OR THE PRODUCTS UNDER TEST.

A rather common means of introducing chlorides occurs when products under test have been defluxed or degreased in a chlorinated solvent and transferred directly into the temperature/humidity chamber. Moreover, parts of vinyl chloride plastics which decompose at sustained high temperature and humidity contribute to deterioration.

C. Failure to institute properly scheduled cleansing and preventative procedures. Failure to follow a rigid schedule of draining and flushing (10 days optimum—30 days maximum) while chamber is in continuous operation will cause a concentration of solids and contaminants (due to water evaporation), and water will become very corrosive.

D. Operating in industrial atmospheres containing a high chloride content.

E. Placing fixture, fasteners, etc., which are not of stainless steel or equal and are not electropolished or properly cleaned of foreign matter, i.e., drill chips, etc., into the chamber.

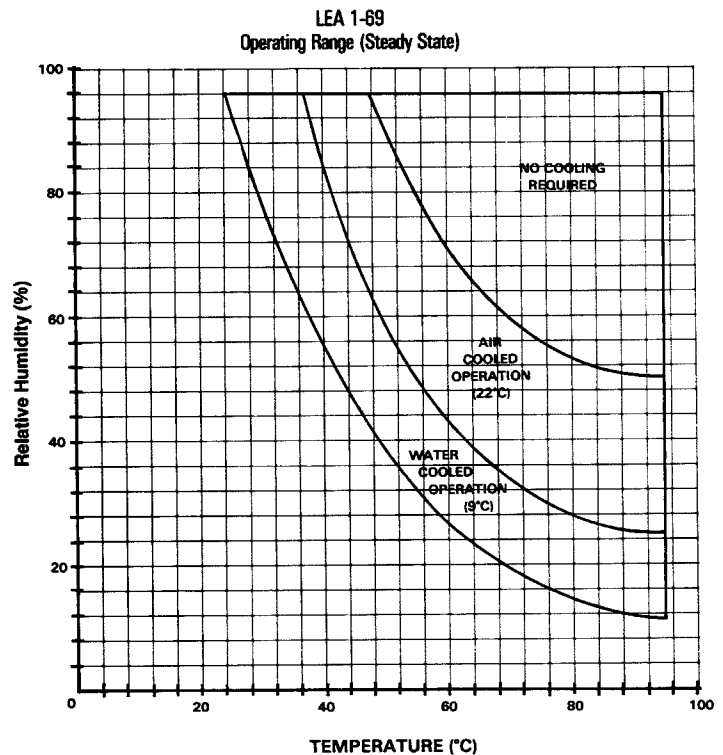

MODEL	Chamber Size in (cm)			Capacity test ³ (liters)	Overall Size in (cm)			Electrical 50/60 Hz 1 Ph			
	W	D	H		W	D	H	Total VOLTS	AMPS	Air Heater KW	Steam Heater KW
LEA 1-69	25 (64)	20 (51)	24 (61)	6.9 (195)	31 (79)	30 (76)	53 (135)	240	22.2	2.4	2.0

CHAMBER OPERATION

Chamber Start-up

- Push power switch to "ON". Power indicator light should light. This switch will activate the fans and control circuit.
- Set temperature control to the desired temperature. See section on temperature control for more information on control instrument.
- Set humidity control to the desired percent relative humidity (%RH). See section on humidity control for more information on instrument, and section on condensation to prevent condensation on parts.
- Refer to operating range graph below for optimum cooling for the range of operation desired. The minimum cooling necessary will provide the best performance. Turn cooling switch on if required. Adjust water flow as necessary.
- Set hi-limit control by dialing in a temperature of 10-15°C (18-27°F) above process temperature. Setpoint should be low enough to prevent damage to the workload but high enough to allow the controller to control at setpoint. Hi-limit will shut off heaters if chamber temperature exceeds hi-limit setpoint. The hi-limit must be manually reset. See section on hi-limit control for more information on the hi-limit instrument.
- Push heater switch to "ON". Heater indicator light should light. This switch will activate the heating elements. When the desired temperature is reached, the control will proportion power to the heater as needed and the heater indicator light will flash on and off.

- Push humidity heater switch to "ON". Humidity heater indicator light may not come on initially as there is an approximate 15 minute delay to fill the steam generator with water. The heater will not function until the generator is full. This switch will then activate the heating elements. When the desired humidity is reached, the control will proportion power to the humidity heater as needed and the indicator light will flash on and off.
- Review the operating range chart below and activate either the air or water cooling, if necessary, to operate at the selected test condition.
- The steam generator hi-limit is located on the back of the chamber. This hi-limit will shut-off the humidity heater, if the steam generator has run out of water. The hi-limit must be manually reset.

Shutting Down the Chamber

- Push the humidity and air heater switches to "OFF" after the test cycle is complete. See section on condensation to prevent condensation on parts.
- Turn the power switch off to shut down the controls and fan.

WARNING: To avoid a cloud of steam when the inner door is opened, the temperature and relative humidity in the chamber may have to be reduced using one or both of the cooling methods.

STEAM BURNS!

- Turning off the oven under conditions of high temperature or humidity may result in condensation on parts after the chamber and parts cool below the dew point.

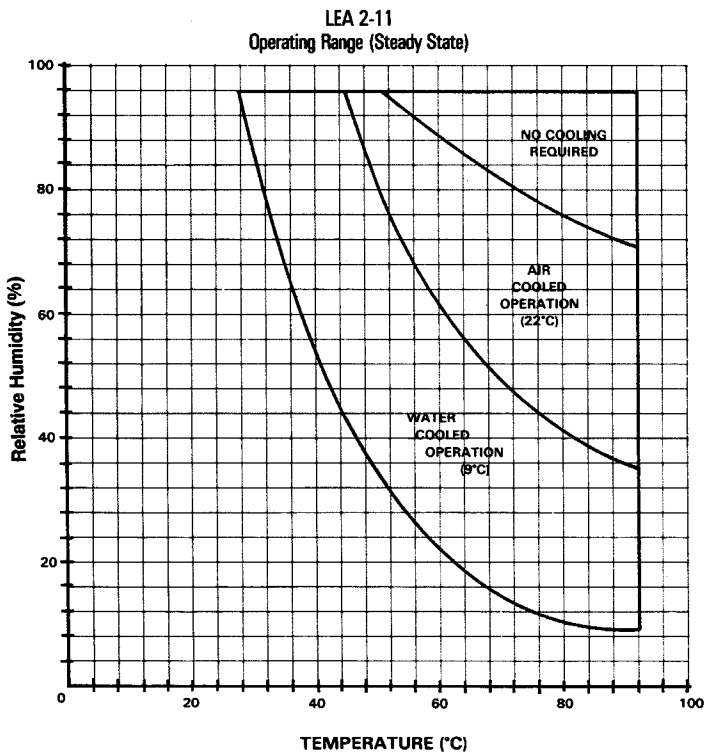

MODEL	Chamber Size in (cm)			Capacity test ¹ (liters)	Overall Size in (cm)			Electrical 50/60 Hz-1-Ph			
	W	D	H		W	D	H	Total VOLTS	AMPS	Air Heater KW	Steam Heater KW
LEA 2-11	37 (94)	20 (51)	26 (66)	11 (311)	51 (130)	28 (71)	76 (193)	240	37.4	4.8	3.0

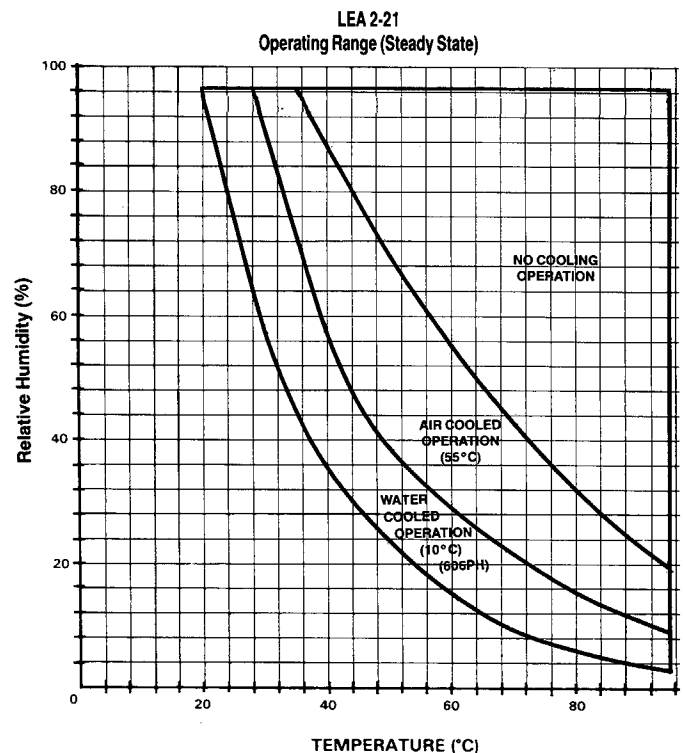

MODEL	Chamber Size in (cm)			Capacity test ¹ (liters)	Overall Size in (cm)			Electrical 50/60 Hz-1-Ph			
	W	D	H		W	D	H	Total VOLTS	AMPS	Air Heater KW	Steam Heater KW
LEA 2-21 V/H	30 (76)	25 (63)	48 (122)	21 (594)	44 (111)	37.62 (95)	84.25 (214)	240	38/ 41	4.8	3.0

TEMPERATURE CONTROL

A. GENERAL INFORMATION

The temperature controller is time proportioning with auto reset and rate adjustments.

A front panel mounted LED indicates when power has been applied to activate the load. During normal operation, the process temperature is continuously displayed on the digital indicator. The unique push-to-set feature allows monitoring or adjusting of the setpoint. Depress push to set knob. Set point will be displayed on digital indicator.

B. DEFINITION OF TERMS:

1. **PROPORTIONAL BAND**—In a straight time proportional control system when the “Actual Process Temperature” is below setpoint and outside the proportional band limit, 100% power is applied to the heater. When the “Actual Process Temperature” is within the proportional band, the controller will proportion the amount of power applied to the heater: 0 to 100%.
2. **TEMPERATURE DROOP**—Phenomenon that occurs in a proportional control system without reset. As the proportional band is increased, the average process temperature may drop to a point that is not the setpoint temperature. This action takes place even though the load temperature has stabilized.
3. **AUTOMATIC RESET (INTEGRAL)**—Used in proportional control systems to automatically pick up any system “droop.” Normally, this action is adjustable and adjusts the “time” for reset to obtain agreement between “Actual Process Temperature” and “Controller Setpoint.”
4. **RATE (DERIVATIVE)**—Action that anticipates the rate of actual process temperature rise and automatically widens the proportional band to prevent “overshoot.” Returns the proportional band to the static adjustment when the setpoint temperature is stable within the static band boundaries.
5. **TEMPERATURE OSCILLATION OR HUNTING**—Occurs when the proportional band is too narrow, the rate and reset adjustments are set too large, or the system is upset by some outside source. The actual load temperature is not controlled within the proportional band on its extreme temperature excursions. Load temperature may never stabilize. Control is either “full on” or “full off,” not within the proportional band.
6. **ZERO SWITCHING**—Heater is activated only during the time period that the A.C. sine wave is going through zero volts. This eliminates RFI and EMI radiation. (Applies to solid state outputs only.)
7. **CYCLE TIME**—The rate at which the controller samples load temperature. If a setting of 2 seconds and 25% power is required to maintain load temperature at setpoint, power will be applied for 1/2 second every 2 seconds.

C. SPECIFICATIONS:

- VOLTAGE - All models 115 VAC \pm 10%, 50/60 Hz.
- POWER CONSUMPTION - Less than 4 V.A.
- OPERATING AMBIENT - 30 to 130°F.
- CONTROL MODE - Time proportioning with automatic reset and rate.
 1. Proportional band front panel adjustment from 0 to 10°C.
 2. Automatic reset internally adjustable 0.0 to 0.5 repeats per minute.
 3. Rate internally adjustable from 0 to 5 minutes.
 4. Cycle time internally adjustable from .5 to 5 seconds.
- INPUTS - RTD sensor
 1. 100 ohms at 0°C.
 2. Temperature coefficient of .00385 ohm/ohm/°C.
- OUTPUTS - Solid state zero switching output for switching a solid state relay.
- TEMPERATURE RANGE - 0 to 100°C.
- CONTROL ACCURACY - \pm 0.25 of span.
- INDICATION - 3 LED digits.
- SIGNAL CONDITIONER OUTPUT - A linear signal in available to input into a digital indicator, programmer (5mv/least significant digit [LSD] output), or a recorder.
- PROGRAMMER INPUT - A linearized input to enable a programmer to control the “setpoint” function of the controller (5 mv/LSD INPUT).
- OPEN SENSOR PROTECTION - Output will de-energize in the event of an open sensor.

The display will indicate an upscale condition, which is (EEE).
- LED LOAD INDICATION - Front panel LED will turn on when the heater is energized.
- SETPOINT SHIFT WITH AMBIENT - Typically, \pm 2 microvolts/°F referred to the input.
- SETPOINT SHIFT WITH LINE VOLTAGE - A change of \pm 10% will produce a shift of less than \pm 0.25% of span.

D. ADJUSTMENT PROCEDURE FOR PID CONTROLS:

1. Initially set the controls as indicated:
 - a. Cycle time - .5 seconds (maximum CCW)

- b. Proportional band (maximum CW)
- c. Rate - 0 (maximum CCW)
- d. Reset - 0 repeats/minutes (maximum CW)

2. Proportional Band Adjustment:

Rotate the proportional band pot CCW 1/4 turn and observe the system stability. Repeat until the temperature begins to hunt. When hunting is observed, rotate slowly CW until the system stabilizes. The system may be stable enough to allow minimum proportional band (maximum CCW).

3. Rate Adjustment:

The rate adjustment controls overshoot as chamber temperature approaches setpoint temperature by limiting the rate of change of chamber temperature. Rotate the rate point 1/4 turn CW. Change the setpoint temperature 20 to 30° F/°C and observe the approach to setpoint. If the chamber temperature overshoots, repeat the procedure until optimum approach to setpoint is achieved. If the rate pot is advanced too far, the system will be overdamped and approach to setpoint will be very sluggish, or the temperature will hunt.

4. Reset Adjustment:

The reset adjustment controls the time required to drive the error signal to zero. A slow setting (.05 repeats/minutes) requires long periods of time for the load temperature to reach setpoint. If the reset time is set too fast (.5 repeats/minutes), the system may become unstable and hunt. To adjust reset time, rotate the reset pot 1/4 turn CCW and observe stability. Continue adjusting CCW until the system becomes unstable. Rotate CW very slowly to regain stability.

5. Cycle Time:

Cycle time is the time base use in proportioning heat or cooling to the chamber. At a setting of 2 seconds, if 25% heater power is required to maintain temperature at setpoint, power will be applied for 1/2 second every 2

seconds. At 10 second cycle time, power would be applied for 2.5 seconds every 10 seconds. Best Control is always achieved with faster cycle times. However, if a mechanical contractor or a solenoid is used to heat or cool chamber slower cycle times may be desirable to minimize the wear on the mechanical components.

NOTE: For ease of adjustment, order extender board P/N 055067.

E. CALIBRATION PROCEDURE:

1. Equipment Required:

- a. 100 ohm decade resistance box.
- b. Digital voltmeter.
- c. Extender board for ease of servicing, P/N 055067.

2. Procedure: Temperature Range: 0 to 100°C

- a. Turn off power to oven. Connect decade resistance resistance box to input terminals 9 and 11 on the control with 11 jumpered to 16. Connect digital voltmeter to terminals 15 (+) and 16 (-). Install control into extender board, if one is in possession. Connect power to the control. Let the control stabilize for 15 minutes before calibration begins.
- b. Set the decade box to 100.00 ohms. Adjust S.C. Lo* pot for 0.000 volts on the digital voltmeter. Adjust the zero* pot for 000 on the display of the control.
- c. Set the decade box to 138.50 ohms. Adjust S.C. Hi* pot for 0.500 volts on the digital voltmeter. Adjust the FS* pot for 100 on the display of the control.
- d. Repeat steps 2 and 3 until all of the readings are correct with no further adjustment necessary.
- e. Check the linearity of the signal conditioner.

Decade Box	Display
119.40	50

*All on upper board.

F. TEMPERATURE CONTROL TROUBLE-SHOOTING

Symptom	Diagnosis	Remedy
No display	Check for presence or proper AC input. A. If not present or proper: B. If present and proper:	Connect per electrical diagram. Return unit to factory.
Display indicates EEE	1. Open RTD 2. If using 2 wire RTD, connect jumper wire between S2 and S3.	Repair or replace. Connect per electrical diagram.
Erroneous display	1. If sensor is connected properly, check for faulty sensor.	Check sensor location, connections and sensing element. Repair or replace as required.

SENSOR CHECK - Place 100 ohm resistor across sensor terminals. If display indicates 0°C or 32°F, indicator is functioning properly.

Symptom	Diagnosis	Remedy
Poor temperature control	1. Chamber temperature unstable.	Adjust proportional band, cycle time, reset and rate per adjustment procedure.
Heater will not turn on	1. Open RTD (Display shows EEE)	Repair or replace.
	2. Check fuses, circuit breakers and heater.	Repair or replace.
	3. Load LED will not turn on.	Return control to factory.
Heater will not turn off.	1. Check solid state relay.	Replace solid state relay.
	2. Load LED will not turn off	Return control to factory.
Cannot control unit with external programmer	1. Internal jumper W25 not removed.	Remove internal jumper wire.

RELATIVE HUMIDITY CONTROL

A. GENERAL INFORMATION:

The relative humidity control offers a primary output to control humidity. It features a digital readout that displays the process RH or the setpoint when called for.

The control utilizes a thermistor sensor for dry bulb temperature compensation and differential Type "E" thermocouples for humidity sensing.

B. SPECIFICATIONS:

- VOLTAGE - All models 115 VAC \pm 10%, 50 Hz.
- OPERATING AMBIENT - 30 to 130°F/O to 55°C.
- DEAD BAND - 0% to 10% RH adjustable through front panel, optional display of actual DB by moving internal jumper.
- CONTROL MODE – Dual PID.
- 1. Humidify Cycle Time – .5 to 5 seconds, internally adjustable.
- 2. Dehumidify Cycle Time – 5 to 50 seconds, internally adjustable.
- 3. Proportional Band - 5 to 50% RH, both outputs independently adjustable internally.
- 4. Reset – 2 to 20 minutes per repeat, internal adjustment to both outputs.
- 5. Rate – 0 to 5 minutes, internal adjustment to both outputs.
- INPUT:
- 1. RH Sensor Input – Thermistor and Dual Type "E" thermocouples. The humidity control accepts a thermistor sensor for dry bulb temperature compensation and differential Type "E" thermocouples for a humidity sensor.
- OUTPUTS
- 1. Primarily – Humidify – Solid state zero switching output for operating a solid state relay.
- SIGNAL CONDITIONER OUTPUT – A linear signal is available to input into a digital indicator, programmer. (5 mv/least significant digit [LSD] output) or a recorder.

— PROGRAMMER INPUT – A linearized input to enable the programmer to control the "setpoint" function of the controller (5 mv/LSD input).

— CONTROL ACCURACY – \pm 0.25% of span.

— RANGE – RH input 0 to 100%.

C. MAINTENANCE OF THE WET/DRY BULB RH SENSOR

The wet junction does require maintenance with the wet sock and water source.

1. The wet sock should be washed out or replaced on a regular basis. A sock that is dirty or contaminated with deposits from the water will have capillary action reduced, thus limiting the amount of water getting to the wet junction. A sock that does not clean up should be replaced.
2. The water has to be maintained. Keep the water system clean and operational.

D. ADJUSTMENT PROCEDURE—DUAL RELATIVE HUMIDITY PID CONTROLS:

1. Initially set the control as indicated:
 - a. Humidify and De-Humidify Cycle time: (maximum CCW).
 - b. Humidify and De-Humidify Proportional Band: (maximum CCW).
 - c. Rate: (maximum CCW).
 - d. Reset: (maximum CW).
 - e. Set II (Dead Band): (maximum CCW).
2. Humidify Proportional Band Adjustment:
 - a. Adjust Set I for the most commonly used Humidity RH.
 - b. Rotate the proportional band pot CW 1/4 turn and observe the system stability. If stable repeat until the chamber humidity begins to hunt. When hunting is observed, rotate slowly CCW until the system stabilizes. The system may be stable enough to allow minimum proportional band (maximum CCW).

3. Rate Adjustment:
 - a. Rotate the rate pot 1/4 turn CW.
 - b. Increase the setpoint 20 to 30%RH, and observe the approach to setpoint. Decrease the setpoint 20 to 30%RH, and observe the approach to setpoint.
 - c. If the humidity overshoots, repeat "a" and "b" until optimum approach to setpoint is achieved. If the rate pot is advanced too far, the system will be overdamped and approach to setpoint will be very sluggish, or may hunt.

same PID settings will work in all identical environmental chambers, once the optimum PID settings have been established.

For ease of adjustment, order extender board P/N 055067.

4. Reset Adjustment:
 - a. Adjust setpoint for 50% RH.
 - b. A slow setting (.05 repeats/mins.) requires long periods of time for the RH to reach setpoint. If the reset time is set too fast (.5 repeats/mins.), the system may become unstable and oscillate about setpoint RH. To adjust reset time, rotate the reset pot 1/4 turn CCW and observe stability. Continue adjusting CCW until the system becomes unstable. Rotate CW very slowly to regain stability.

5. Set II (Dead Band) Adjustment:

Dead Band is adjustable from 0-10% RH. It should be adjusted for 01 for this chamber (maximum CCW).

6. Cycle Time Adjustment:

Best control is always achieved with faster cycle times. Turn cycle time pot CW for slower cycle times.

NOTE: PID set-up in a complex system is not a 5-minute task, but may require an 8-hour day, depending on the thermo-dynamics of the system. A chart recorder is recommended for observing RH changes.

All PID settings should be at nominal RH settings. The PID settings may require fine tuning when operating at different RH. The

E. CALIBRATION PROCEDURE:

1. Equipment Required:
 - a. Precision millivolt source.
 - b. Precision Decade Resistance Box.
 - c. Digital Voltmeter (DVM).
 - d. Extender board for ease of servicing, P/N 055067.

2. Procedure:
 - a. Connect millivolt (M.V.) source to terminals S1 (+) and S2 (-). Connect the decade resistance box (100K) to terminals S3 and S4, decade box case to S4.
 - b. Set decade resistance box to 76.43K. Set M.V. input to zero. Connect the Digital Voltmeter (D.V.M.) from terminals S4 to S2 (-). Adjust the 0% R.H. pot for 0000 ± 5mV on the D.V.M. Set the 100% max pot full CW.
 - c. Connect the D.V.M. to terminals 15 (+) and 16 (-). Set the M.V. input to +.622 mV. Set the decade resistance box to 45.49K. Adjust the 10% R.H. pot for an indication of .050V on the D.V.M. Adjust the zero pot for 010 on the display of the control.
 - d. Set the M.V. input to 0.000 M.V. Adjust the 100% R.H. pot for an indication of .500V on the D.V.M. Adjust the F.S. pot for 100 on the display of the control.
 - e. Repeat steps c and d until proper indication is obtained.
 - f. Set the M.V. input to .316 MV, the control display should read 050 ± 1.

HUMIDITY CONTROL TROUBLESHOOTING:

Symptom	Diagnosis	Remedy
No display	Check for presence or proper AC input A. If not present or proper: B. If present and proper:	Connect per electrical diagram. Return control to factory.
Display indicates 0 or 100% RH	1. Open sensor. 2. Sensor connection reversed. 3. Check for clogged sensor wick.	Repair or replace. Connect per electrical diagram. See section on wet wick maintenance on Page 15.
Erroneous display	1. Check sensor connections. 2. If sensor is connected properly, check for faulty sensors.	Check sensor location and sensing element. Repair or replace sensors as required.

Poor humidity control	1. Chamber temperature unstable. (Most easily checked with humidity heater off.)	Adjust proportional band, cycle time, reset and rate per adjustment procedure. See temp. control section on adjustment for PID controls.
	2. Humidity control tuning.	See relative humidity control adjustment procedure.
	3. Check solid state relays.	Replace solid state relay.
Control load light unsteady	1. Check sensor connections.	Tighten and connect per electrical diagram.
Will not turn off	1. Open sensor.	Repair or replace.
	2. Check fuses, circuit breakers and humidity heater.	Repair or replace.
	3. Load LED will not turn on.	Return control to factory.
	4. Check solid state relay.	Replace solid state relay.
Cannot control unit w/external programmer	1. Internal jumper W-110 is not removed.	Remove internal jumper wire.

STANDARD HI-LIMIT CONTROLLER

The Honeywell Dialapak hi-limit controller in a miniaturized instrument featuring advanced solid state circuitry to provide a hi-limit cutoff control function. The controller has a manual resetting feature to reset controller after any over temperature.

HI-LIMIT TROUBLESHOOTING CHART

The following symptoms use the instrument's meter indication as an aid in isolating a malfunction to a particular area of the instrument.

Symptom	Probable Cause	Suggested Remedy
Meter inoperative	Defective a-c power supply.	Return hi-limit to factory
Meter at or near zero at all times	Open meter or circuit board connections to front assembly.	Return hi-limit to factory
Meter upscale	Open sensor circuit. Open compensator (T/C models).	Check for faulty sensor

OPTIONAL HI-LIMIT AND HUMIDITY RECORDER

This instrument performs the hi-limit function. Therefore the standard Honeywell Dialapak hi-limit is not provided when this option is offered.

RECORDER SPECIFICATIONS

Pen #1 records temperatures from 0-100°C.
Pen #2 records relative humidity from 0-100 RH.

8" diameter circular chart.
Disposable fiber tip cartridges used.
Red for pen 1, green for pen 2.
7-day standard rotation.
120 Volt, 60 Hz.

NOTE: The hi-limit must be manually reset after an overtemperature condition.

Recorder Adjustments

1. THUMBWHEEL SWITCH

- A. The setpoint for the hi-limit can be set by dialing in the desired temperature into the thumbwheel switch located in the upper right hand corner of the recorder.
- B. **NOTE:** Hi-limits must be manually reset after an over-temperature condition exists.

2. RTD BREAK PROTECTION

The hi-limit incorporates RTD upscale break protection.

3. RTD CHANGE

RTD recorders are provided with 3-wire RTDs. For use with 2-wire RTDs, perform the following:

- A. Open control cover to expose circuit boards.
- B. Locate satellite RTD board mounted on stand-offs in the lower left corner of the main circuit board.
- C. Locate Terminal Block XTB1.
- D. For a 2-wire RTD, install a short jumper between XTB1-1 and XTB1-2.
- E. Lead length correction must be taken into account for 2-wire RTD.
Example: For this recorder, a 2-wire RTD with #20 gauge wire leads has a maximum lead length of 9.5 feet. The maximum length for #18 gauge wire is 15 feet.

4. RECORDER CALIBRATION

- A. Pen #1 Hi-Limit Calibration Procedure
 1. Turn power switch off.
 2. Disconnect sensor input and turn heater and immersion heater switches off.
 3. Connect decade box to terminals XTB1-2 and XTB1-3.
 4. Clip black lead of digital voltmeter to TPC.
 5. Clip red lead to TP6.
 6. Turn power switch on.

STARTUP AND OPERATION

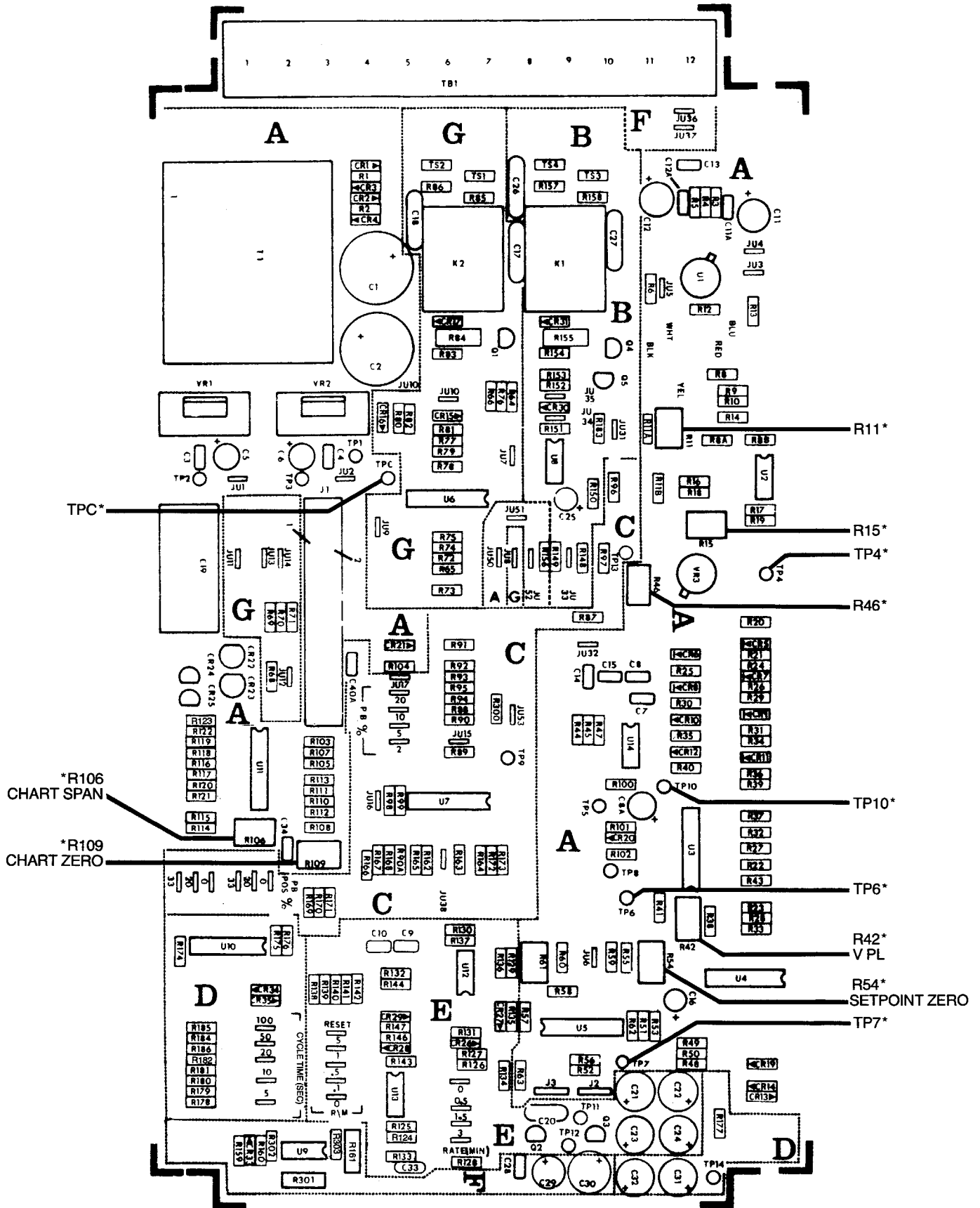

7. Adjust R46 for -5.000 ± 0.001 VDC.
8. Move red lead to TP4.
9. Adjust decade box for 100 ohms (0°C).
10. Adjust R11 for 0.000 ± 0.003 VDC.
11. Move red lead to TP10.
12. Adjust R42 for 0.000 ± 0.003 VDC.
13. Adjust R109 so that pen is at minimum of span (0°C).
14. Adjust decade box for 138.5 ohms (100°C).
15. With red lead on TP10 adjust R15 for $10.000 + 0.001$ VDC.
16. Adjust R106 so that pen is at maximum of span (100°C).
17. It may be necessary to go through procedure again to make sure zero and span do not shift.
18. Set the thumbwheel to 10°C .
19. Move red lead to TP7.
20. Adjust R54 for -0.5 ± 0.001 VDC.
21. Set the thumbwheels for 90°C .
22. With red lead on TP7 adjust R61 for -4.500 ± 0.001 VDC.
23. Repeat steps 14 through 18 until satisfactory results are obtained.
24. Adjust setpoint to midchart.
25. Adjust the decade box to make pen read the desired setpoint (119.40 ohms at 50°C). The red light will be on above setpoint.

B. Pen #2 Relative Humidity Recorder Calibration Procedure.

1. Turn power switch off.
2. Disconnect input leads and connect voltage source instead.
3. Clip back lead of digital voltmeter to TPC.
4. Clip red lead to TP6.
5. Turn power switch on.
6. Adjust R46 for -5.000 ± 0.001 VDC.
7. Move red lead to TP4.
8. Adjust input voltage device for 0.00 ± 0.003 VDC ($0\% \text{ RH}$).
9. Adjust R11 for 0.000 ± 0.003 VDC. lead to TP6.
10. Move red lead to TP10.
11. Adjust R42 for 0.000 ± 0.003 VDC.
12. Adjust R109 so that pen is at minimum of span ($0\% \text{ RH}$).

13. Adjust input voltage device for 0.500 ± 0.003 VDC ($100\% \text{ RH}$).
14. With red lead on TP10 adjust R15 for 10.000 ± 0.001 VDC.
15. Adjust R106 so that pen is a maximum of span ($100\% \text{ RH}$).
16. It may be necessary to go through procedure again to make sure zero and span did not shift.

Recorder Troubleshooting

Symptom	Probable Cause	Suggested Remedy
1. No pen movement or indicator lights.	Loose wire	Check all power wiring
2. Pen reads full upscale	Faulty sensor	Check sensor leads for breaks or sensor polarity
3. Incorrect indication or control	Faulty connections	Check for resistance build-up on terminals
	Out of calibration	Check output wiring, correct contacts
4. No output, but indicator light functions properly	See section on recorder calibration on Page 13	Check output wiring, correct contacts

OPTIONAL PROCESS TIME INSTALLATION

This option is normally factory installed, but can be installed in the field following these steps.

The timer is electrically connected into oven control circuit and will shut off the heater at end of cycle. (Tools needed: screwdriver, utility knife, hack saw)

1. Disconnect power, remove screws from the face of the control panel and swing it forward.
2. From back of panel, locate pre-punched holes for process timer and timer switch. From the front of panel, use utility knife to cut holes in the overlay. Use saw to cut and remove sheet metal.
3. Mount timer to housing before mounting in the panel. Make sure rubber gasket is flush with timer bezel before tightening the screws.
4. Slide timer/housing complete through cut out until the gasket is against panel.
5. Holding the timer in place, install the mounting bracket horizontally around the timer housing and slide it forward until the ends contact the rear of the panel.
6. Using the two screws provided, attach the bracket to the timer housing and tighten screws until timer is held securely in place.

7. Install mylar insulator over rear of bracket by sliding the the end tabs between the bracket and the housing and allowing metal extensions on rear of bracket to go through the slots in insulator to hold it securely in place.
8. Locate terminals marked #7 and #8 (to shut down heater only) on the terminal strip. Remove jumper. Wire timer in the circuit as shown below. (Instead of terminals #7 and #8 use #3 and #4 to shut down fan and heater). See page 19 for Wiring Diagram.
9. Peel top part of backing off "Timer" sticker and apply it to front of control panel, using the two locating marks and switch hole as location guides. Peel remaining backing off and smooth sticker down.
10. Snap switch into place and wire as shown above.
11. Replace control panel.

MAINTENANCE

1. Keep Equipment Clean

Gradual dirt accumulation impedes air flow. A dirty chamber can result in unsatisfactory operation such as non-uniform temperatures and/or humidity in the work chamber, reduced heating capacity, reduced production, overheated components, corrosion, etc.

Keep the walls, floor and ceiling of the work chamber free of corrosion, dirt, and dust. Floating dust or accumulated dirt may produce unsatisfactory test results.

Keep all equipment accessible. Do not permit other materials to be stored or piled against chamber.

2. Protect Controls Against Excessive Heat

This is particularly true of controls, motors or other equipment containing electronic components. Temperatures in excess of 38°C (100°F) should be avoided.

3. Establish Maintenance and Check-Up Schedules

Recommended frequency for scheduled maintenance is included in each section.

Follow these promptly and follow them faithfully. Careful operation and maintenance will be more than paid for in continuous, safe economical operation.

4. Maintain Equipment in Good Repair

Make repairs immediately. Delays may be costly in added expense for labor and materials and prolong eventual shutdown.

5. Lubrication

Fan motor bearings are permanently lubricated.

All door latches, hinges, door operating mechanisms, bearing or wear surfaces should be lubricated to ensure easy operation.

6. Check Safety Controls

This should be done as indicated.

Make these tests carefully and do them regularly. The safety of personnel as well as the equipment may depend upon the proper operation of any one of these controls at any time.

a. Temperature and Humidity Controllers (weekly)

Observe that the air and humidity heater indicator lights flash every 1 to 2 seconds when the controls are operating at setpoint.

b. Hi-Limit (weekly)

With the oven operating at a given temperature, gradually turn the hi-limit control down to the setpoint operating temperature. The hi-limit should trip and shut off heater. Return hi-limit setting to normal and reset unit.

7. Practice Safety

Make it a prime policy to "know what you are doing before you do it." Make CAREFULNESS, PATIENCE and GOOD JUDGMENT the safety watchwords for the operation of your chamber.

8. Ventilation

There are fresh air and exhaust openings in the rear and sides of the chamber that are always open to provide cooling for the chamber heat exchanger and control compartment.

9. Blower Shaft Seal

If chamber appears to use excessive amounts of water and water level control is operating properly, check blower shaft seal for leakage. If worn, remove and replace.

10. Door Gaskets & Ports

Periodically inspect inner and outer door gaskets and port sealing for cracking, tearing, etc. If gaskets or seals are damaged, remove and replace. Strip old gasket from channel and force new gasket in.

11. Wet Bulb Wick

Replace at least every 30 days or sooner if discoloration is noticed. Failure to replace when necessary will result in higher RH operation than desired. Replace wick after long duration high temperature and humidity tests, or as necessary.

12. Cleaning

A. Periodically clean all dust and grime from interior of control enclosure and blower compartment.

B. Work Chamber Interior

Program outlined below is minimal; if chamber is operated under abnormal conditions (i.e., dirty water supply, contaminated test loads, corrosive atmosphere, etc.) increase frequency of cleaning.

1. Every 500 operating hours: Drain and clean wet bulb wick assembly, control sensors, and all interior surfaces (walls, bottom, door interior). Use clean cloth and warm water. If necessary, use stainless steel wool or Scotchbrite pads on stains. **UNDER NO CIRCUMSTANCES USE ORDINARY STEEL WOOL: THIS WILL SCRATCH AND CAUSE CORROSION. DO NOT USE STEEL WOOL OR SCOTCHBRITE PADS ON INTERIOR OF CHAMBER IF THEY HAVE BEEN USED ELSEWHERE.**
2. Every 2,000 operating hours: Remove interior baffles, wet and dry bulb assembly, and sensors. Clean all interior surfaces, including all sensors, with mild detergent. Scrub all exposed surfaces until clean, using stainless steel wool or Scotchbrite pad if necessary (See "1"). Rinse thoroughly and dry with clean cloth. Remove contaminants from water reservoir. Install all components removed earlier, fill reservoir, drain, and refill again.
3. When humidity chamber is under continuous use for high temperature/humidity testing, water system **MUST** be drained after every test cycle. Chamber should be cleaned as is necessary to remove any stains or corrosion, then water system may be refilled with water. Optimum cleaning (as outlined "1" and "2") interval under these conditions is ten days. Maximum interval is 30 days.

13. Optional Demineralizing Cartridges

A. As cartridge is used, contents will begin to change color. When resin color change reaches line on label located at bottom end of cartridge, turn off water supply, remove, and replace cartridge.

Remove the left cartridge and shift the right cartridge to the left side and replace the right cartridge with a new one to return to full potential. See cartridge installation instructions.

B. Cartridge Installation Instructions

Bracket Installation

This option is normally factory installed, but can be installed in the field following these steps.

- 1) Place bracket (A) in a vertical position. Attach by screws (B) through holes in bracket.
- 2) Place upper pressure fittings (C) in the two outside top slotted holes in the bracket. While holding the pressure fittings, screw the shut-off valve (E) and the threaded elbow (F) into the threaded end of the pressure fittings (C).
- 3) Place the Teflon washers (M) over the bottom end of the lower receiving blocks (G) and then insert the lower receiving blocks and washers into the two outside bot-

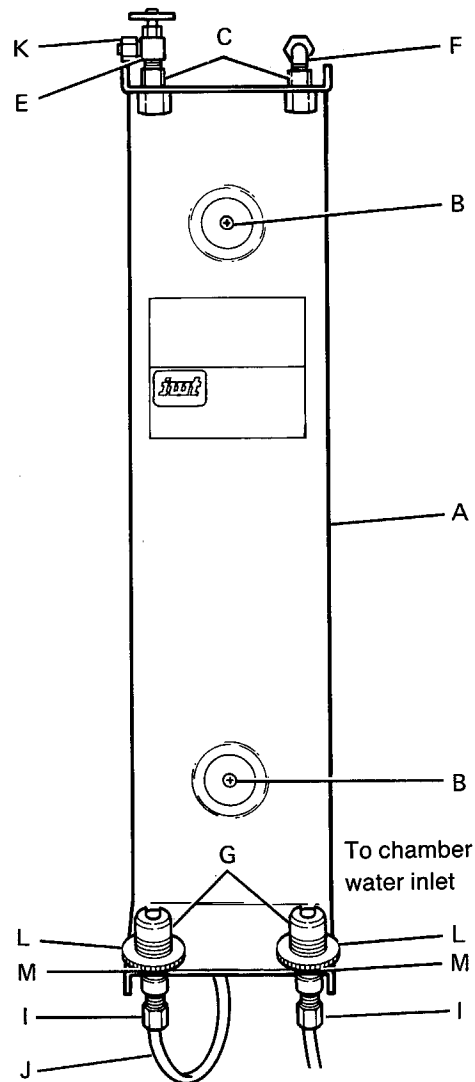

tom holes. While holding each receiving block, loosely screw the nylon nut (I) onto the receiving block. Be sure the slotted openings on the receiving blocks are facing you to allow entry of the cartridges.

- 4) Connect the long piece of tubing (J) to the left lower receiving block (G) by pushing the tubing completely into the receiving block through the nylon nut (I) and tighten the nylon nut approximately 1/2 turn after finger tight.
- 5) Pass the long piece of plastic tubing (J) behind the bracket upwards to connect to the threaded elbow (F). Connect the tubing, using the same method as described in step 4.
- 6) Connect tubing (preferably plastic) from the water supply to the inlet shut-off valve (E) by passing the tubing through the brass nut (K) and tightening as described in step 4.
- 7) Connect tubing (preferably plastic) to the right lower receiving block as described in step 4 for the outlet.
- 8) Attach free end of outlet tubing to inlet of oven. (Marked water inlet.)

C. Cartridge Installation

- 1) Remove the protective end caps from a cartridge. Detach the two washers that are taped to the cartridge and place one washer on the top of the cartridge and then push the washer and cartridge into the upper receiving block (C). While holding the cartridge in this position, place the remaining washer into the lower receiving block (G) and slide the cartridge into place. Tighten the adjusting nut (L) on the lower bracket. Only moderate tightening should be necessary to prevent leakage. Repeat for second cartridge.
- 2) To obtain water flow, open shut-off valve (E) and regulate for proper flow with either the shut-off valve or the outlet valve if one is installed. (Outlet valve is not provided in kit.)
- 3) To replace the cartridge, turn off inlet shut-off valve (E) and loosen the adjusting nut (L) on the lower receiving block (G). Pull cartridge from the bottom, disengaging

it slightly from the lower receiving block before removing it completely from the bracket. Repeat for second cartridge.

D. Warnings

1. Water pressure is not to exceed 100 pounds per square inch.
2. Install pressure reducing valve where line pressure is greater than 100 psi.
3. Water temperature is not to exceed 100°F.
4. Do not store cartridges in area where temperature will be below 33°F. or above 100°F.
5. **When mounting cartridge in bracket, tighten nut moderately tight and turn on water. If leak occurs, tighten nut until leak is stopped.**
6. Cartridge stock should be rotated. Guaranteed shelf life is 2 years.

CHAMBER TROUBLE SHOOTING

Below are possible operating problems and suggested solutions. If you have a problem not listed and don't know what to do, contact Despatch at our toll free "Help Line" 800-328-5476 (in MN 800-462-5396).



DIFFICULTY	PROBABLE CAUSE	SUGGESTED REMEDY
Failure to heat	No power	Check power source and/or oven and wall fuses.
	Burned out heating element	Replace element (see warranty statement).
	Control malfunction	See trouble shooting information in temperature control section.
	Loose wire connections	Disconnect power and check connections behind control panel.
Slow heat up	Improperly loaded	Reduce load or redistribute load in work chamber.
	Low line voltage	Supply sufficient power and proper connections. Check to see if circuit is overloaded.
	1 or 2 heating elements burned out	Replace burned out element (see warranty statement).
	240 volt chamber is connected to a 208 volt line	Add boost transformer to chamber.
	Fan motor failure	Check thermal protection (automatic reset). Replace fan motor.
Frequent heater element burn out	Water flow in cooling coil or cooling switch is on.	Shut water off or turn cooling switch on (see operating range curve).
	Harmful fumes generated by load	Discontinue process.
	Overheating chamber	Do not operate over 100°C (212°F).
Erratic temperatures or humidity	Control malfunction. Fluctuating or excessive live load. Excessive coding for control tuning.	See trouble shooting information on controls. Smooth or reduce electrical load. Reduce cooling or see control tuning procedure.

DIFFICULTY	PROBABLE CAUSE	SUGGESTED REMEDY
Humidity heater indicator light will not come on	There is a 15 minute time delay while steam generator fills.	See chamber start-up procedure.
Inaccurate temperatures or humidity	Control miscalibration	Recalibrate control (see section on control recalibration).
Excess moisture between doors	Inner door seal deterioration	Replace inner door seal.
Improper airflow	Fan motor failure	Replace fan motor.
	Unbalanced fan wheel	Replace fan wheel.
Excessive vibration	Dirty fan wheel	Clean fan.
	Unbalanced fan wheel	Replace fan wheel.
Chamber will not control at setpoint	Hi-limit set too low	Set the hi-limit higher.
	Hi-limit is out of calibration	Recalibrate the hi-limit (see directions on recalibrating the hi-limit).
	Solid state relay malfunction	Replace relay.
	Control malfunction	See trouble shooting information on control.
	Air friction of recirculation fan is more than cooling capacity.	The minimum operating temperature is approximately 35°C above ambient room temperature. Use water cooling coil. See section showing operating range curve.
	Live load too large	Load work chamber with fewer devices.
	Water flow in cooling coil or cooling switch is on	Shut water off or turn cooling switch off (see operating range curve).
Heater does not shut off until the temperature reaches the hi-limit setting	Solid state relay shorted	Replace relay.
Condensation around door or in motor compartment	Door seal deterioration	Replace door seal.
	Fan shaft seal leaking	Replace shaft seal (remove fan motor first).
Condensation on load	Temperature of load is below dewpoint	See condensation section in chamber operation on how to avoid this problem.
Water spilling out front drain pan (LEA 1-69)	Not enough head between chamber and drain	Chamber should be used on a bench or cabinet (LEA 1-69). Use larger I.D. or shorter drain hose.

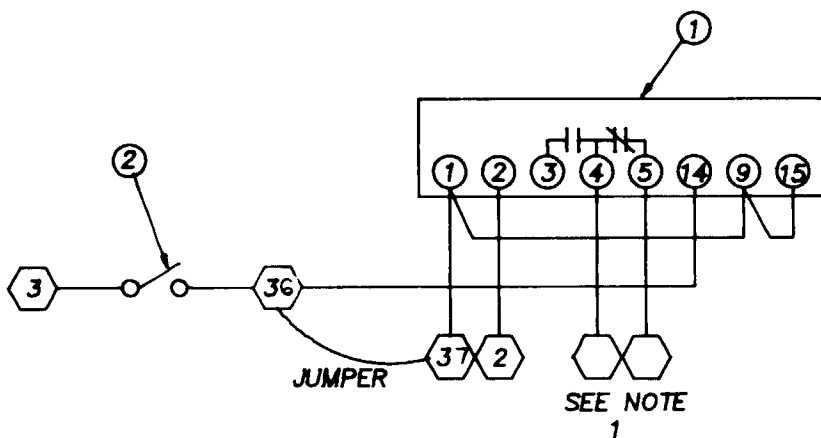
ITEM	P/N	DESCRIPTION
1	032173	ATC 999HR TIMER
2	032225	SWITCH



ELECTRIC SCHEMATIC

-  EQUIPMENT TERMINAL STRIP NUMBERS
-  ELECTRIC COMPONENT NUMBERS

NOTES:

- 1) TO SHUT DOWN THE HEATER ONLY, CONNECT (4) TO (7) AND (5) TO (8) . REMOVE JUMPER 7-8.
TO SHUT DOWN THE HEATER & FAN CONNECT (4) TO (3) AND (5) TO (4) . REMOVE JUMPER 3-4.



OPTIONAL TIMER

A	B361	- WDIO53	A	O1
SIZE	CODE	PART NUMBER	REV.	SERIES

LEA SERIES BILL OF MATERIAL						
Quantity				Item	Part No.	Description
1-69	2-11	2-21V	2-21H			
1	1	1	1	1CI	054631	CTL 808G-0105-09AS 0-100°C RTD
1	1	1	1	2CI	054630	CTL 836B-1500-03AB 0-500 MV
4	4	4	4	1-SCR	047753	Relay Midtex 187-32T200 200 VAC
1	1	1	1	CF	015229	Fan MU3A1 240V Cabinet
1	1	1	1	Cool Fan	057870	Fan Blower B45 230
1	1	1	1	1FL	061103	SW LIQ LEV #15-650-P Magn. Reed
2	2	2	2	1FU	007609	Fuse 1-Element 250V 10 Amp
2	0	0	0	3FU	007456	Fuse A25 x 15 Amp Trap
0	2	2	2	3FU	013217	Fuse A25 x 25 Amp Trap
2	0	0	0	4FU	007456	Fuse A25 x 15 Amp Trap
0	2	2	2	4FU	007457	Fuse A25 x 20 Amp Trap
3	3	3	3		007471	Fuse Block F030A2SP
1	1	1	1	2HL	052162	CTL 102K Manual Reset Hi-Limit
1	2	2	2	1HT	054266	Htr WGN 2.4KW SST 240V
1	0	0	0	2HT	007820	Htr Watlow Frod Cart 2000W 230V
0	1	1	1	2HT	007821	Htr Watlow Frod Cart 3000W 230V
1	1	1	0	Rec Mtr	101752	Mtr 00.25 HP SODP208230-1-60 56C
2	2	2	2	1-2SSR	047610	Relay Opto-22 #240D25
2	2	2	2	1-2SW	012148	SW CRL LL-021-AABD-08-C-XBE1
2	2	2	2	3-4SW	012150	SW CRL LL-021-AADF-08-C-XBE1
1	1	1	1	1T	013315	Tranf Mt 200VA BX 200MP 12153 PK
2	2	2	2		007502	Fuse FNM 02.00A 250V
1	1	1	1	RTD	070070	RTD 100 Ohm .188 Dia x 3" L
1	1	1	1	Ther.	053310	Therstor Watlow for LEA
2	2	2	2	T/C	053455	T/C E3X 11-3-SPEC23 3" L

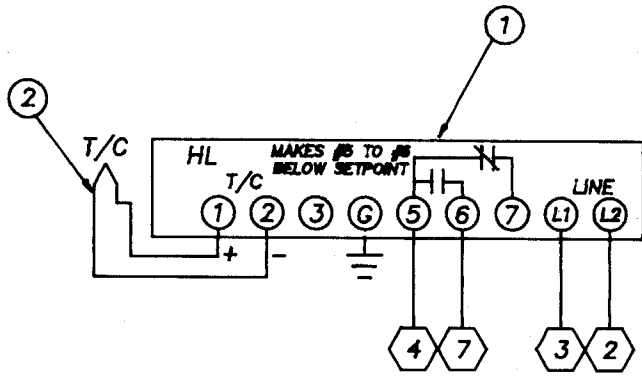
ITEM	P/N	DESCRIPTION
1	005423	HONEYWELL DIALAPAK HI-LIMIT
2	053453	T/C TYPE J



 EQUIPMENT TERMINAL STRIP NUMBER
 ELECTRIC COMPONENT TERMINAL NUMBERS



STANDARD HI-LIMIT

A	B361	-WD1053	A	O2
SIZE	CODE	PART NUMBER	REV.	SERIES

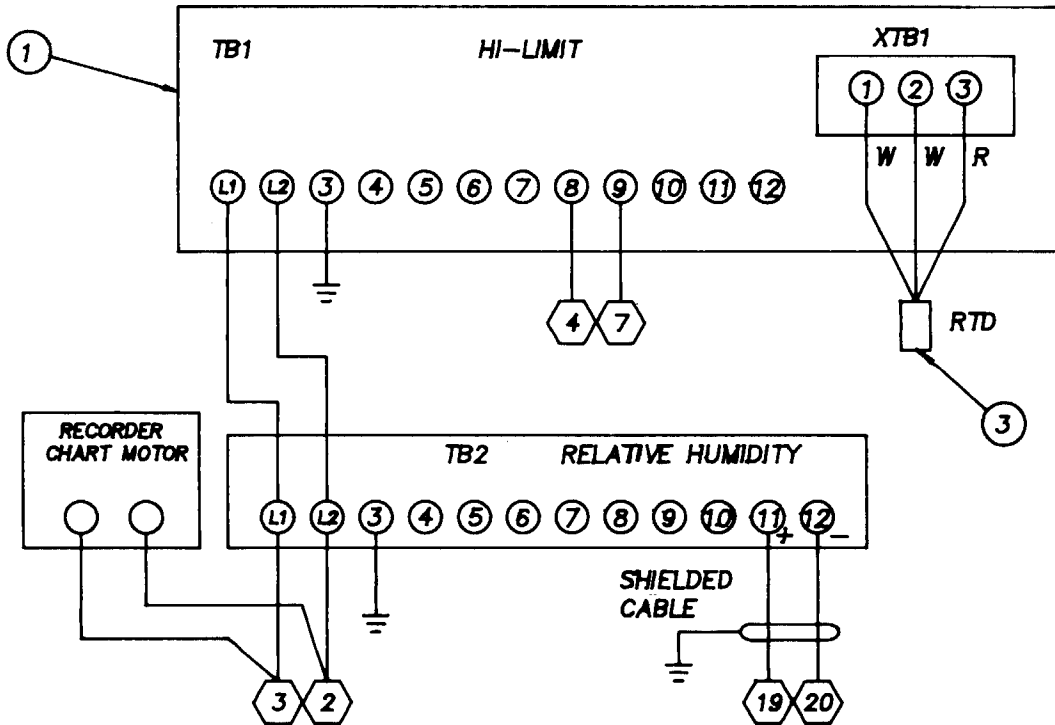
ITEM	P/N	DESCRIPTION
1	054464	RECORDING HI-LIMIT
2	054465	RECORDER CHARTS
3	070070	RTD 100DHM PLTM



ELECTRIC SCHEMATIC

-  EQUIPMENT TERMINAL STRIP NUMBERS
-  ELECTRIC COMPONENT TERMINAL NUMBERS

OPTIONAL RECORDING HI-LIMIT
(REPLACES STANDARD HI-LIMIT)

A	B361	-WDIO53	A	O3
SIZE	CODE	PART NUMBER	REV.	SERIES

Industrial Equipment Commercial Warranty

Despatch Industries, Inc. warrants equipment manufactured by Despatch Industries, Inc., to be free from defects in workmanship and materials under normal use and service for a period of one (1) year from the date of delivery or the period of twenty-one hundred (2100) accumulated hours of use, whichever period is shorter.

Components manufactured by others, including but not limited to expendable items, are excluded from this warranty and are warranted (if at all) only in accordance with the warranty, if any, issued by such other manufacturer.

Use or service with corrosive or abrasive chemicals or materials is not deemed normal.

If Purchaser gives written notice specifying the particular defect or defects within 14 days after discovery thereof, Despatch Industries, Inc. will correct without charge any workmanship that is demonstrated to Despatch Industries, Inc. satisfaction to have been defective at time of installation or erection and will repair or replace, at the warrantor's option, without charge, f.o.b. Despatch Industries, Inc. factory, parts covered by this warranty that upon inspection are found defective under normal use within the warranty period above stated.

All work of removal and reinstallation or installation of parts, whether or not found defective, and shipping charges for defective or replacement parts shall be at the sole expense of Purchaser.

The foregoing warranty shall not apply to equipment repaired or altered by others, unless such repairs or alterations were specifically agreed to in writing by an officer of Despatch Industries, Inc.

Despatch Industries, Inc. shall not be liable for incidental or consequential damages of any kind (whether for personal injury, lost profits or otherwise), whether arising from breach of this warranty, negligence or other tort or otherwise, which occur during the course of installation of equipment, or which result from the use or misuse by user, its employees or others of the equipment supplied hereunder, or from any malfunction or nonfunction of such equipment, and Purchaser's sole and exclusive remedy against Despatch Industries, Inc. for any breach of the foregoing warranty or otherwise shall be for the repair or replacement of the equipment or parts thereof affected.

The foregoing warranty shall be valid and binding upon Despatch Industries, Inc. if and only if user loads, operates and maintains the equipment supplied hereunder in accordance with the instruction manual to be provided upon delivery of the equipment.

Despatch Industries, Inc. does not guarantee the process of manufacture by user or the quality of product to be produced by the equipment supplied hereunder and Despatch Industries, Inc. shall not be liable for lost profits.

THE FOREGOING WARRANTY IS EXCLUSIVE AND IN LIEU OF ALL OTHER EXPRESS AND IMPLIED WARRANTIES AND REPRESENTATIONS WHATSOEVER, INCLUDING BUT NOT LIMITED TO THOSE OF MERCHANTABILITY OR OF FITNESS FOR A PARTICULAR PURPOSE.

**Despatch Industries, Inc. • P.O. Box 1320 • Minneapolis, MN 55440-1320
612/331-1873 • Telex 29-0704 • Easy Link 6288-5512 • FAX 612/623-0257**

Despatch

IM 11/86 NS
PRINTED IN U.S.A.