

Instruction Manual for LDB series ovens

C-21
P/N 023044
REV 10/83

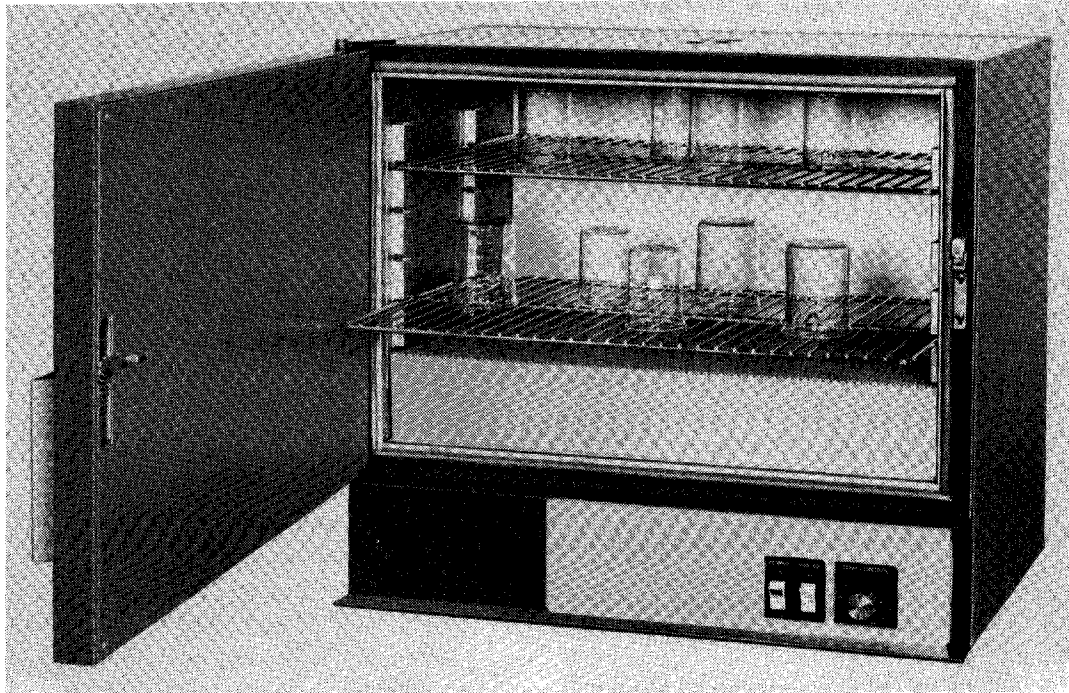

LDB series Despatch ovens are bench ovens to 204°C (400°F) with forced convection airflow. (Oven shown with optional accessories)

MODEL	VOLTS	HEATER WATTS	AMPS	HZ	PHASE
LDB 1-17	120	1200	11.6	60	1
LDB 1-24	120	1200	11.6	60	1
LDB1-43	120	1600	15.0	60	1
LDB 1-69	120	2400	21.6	60	1
LDB 2-18	240	3600	16.6	60	1
LDB 2-27	240	4800	21.6	60	1



DESPATCH
INDUSTRIES, INC.

Box 1320, Minneapolis, Minnesota 55440 (612) 331-1873 Telex 29-0704

3965 Nashua Dr., Mississauga, Ontario L4V 1P3 (416) 677-4951 Telex 06-983-598

INTRODUCTION

The Despatch LDB series ovens are sturdy, compact and economical units with forced airflow for reliably uniform heat. To obtain optimal results from your Despatch oven, thoroughly familiarize yourself with this manual and the various procedures outlined.

WARNING: Failure to heed these restrictions can result in property damage, serious bodily injury or death.

DO NOT use oven in wet, corrosive, or explosive atmosphere.

DO NOT attempt any service on this equipment without disconnecting the main power switch or power cord.

DO NOT exceed maximum operating temperature of 204°C (400°F).

DO NOT use any flammable solvent or other flammable materials or enclosed containers in the oven.

REPLACE 3F fuses with NON-6 or OT-6 (250V, 6 AMP) only.

FOR supply connections on LDB 1-69 (240V) use 14 AWG or larger wires; LDB 2-18 use 12 AWG or larger wires; and LDB 2-27 and LDB1-69 (120V) use 10 AWG or larger wires. All wires must be suitable for at least 75°C (167°F).

Unpacking, Inspection and Packing List

Remove all packing materials and inspect the oven for damage. If damaged, and damage is due to shipment, contact the shipper immediately. If oven parts are damaged, or if parts are missing, contact Despatch Customer Service at 800/328-5476. (In MN 800-462-5396)

You should have in this box:

- One oven
- Two shelves
- One package containing four rubber feet
- One thermometer taped to the shelves
- One operators manual
- Warranty card

Any optional accessories ordered will be shipped separately.

Installation

Remove the adhesive backing sheet from the rubber feet and attach the rubber feet to the bottom corners of the oven.

Place the oven on a bench top or an optional cabinet base. The oven must have a minimum of 2" clearance in the rear to provide proper ventilation but may be placed next to another cabinet or oven with 1/2" clearance (the doors will still open).

Make sure oven is level and plumb; this will assure proper heat distribution and operation of all mechanical components.

LDB 1-17 or LDB 1-24 uses a standard 120 volt, 15 amp circuit. LDB1-43 uses a standard 120 volt, 20 amp circuit.

If you have an LDB 1-69, 2-18 or 2-27, check the oven power requirements for amperage and voltage on the cover of this manual. Connect the electric supply directly to your oven (see electrical schematic in back of manual) with all required grounding and safety equipment, in compliance with applicable codes, ordinances and accepted safe practices.

A note on line voltage: Line voltages may vary according to your geographical location. If line voltage is significantly lower than oven voltage rating, heat up times will be extended, and motor may overheat. If line voltage varies $\pm 10\%$ from the oven voltage rating, temperature control will operate erratically.

Ovens designed for 240 volts (see name plate on oven) will operate satisfactorily on a minimum of 208 volts, but with a reduction in heater power. If your power characteristics are lower, contact Despatch Industries, Inc.

A. PRE-START UP

1. KNOW THE SYSTEM

Read this manual carefully. Make use of its instructions and explanations. The "Know How" of safe, continuous, satisfactory, trouble free operation depends primarily on the degree of your understanding of the system and of your willingness to keep all parts in proper operating condition.

2. CHECK LINE VOLTAGE

This must correspond to nameplate requirements of motors and controls. A wrong voltage can result in serious damage.

3. FRESH AIR DAMPER

Do not be careless about restrictions in and around the fresh air and exhaust openings and stacks. Under no condition, permit them to become so filled with dirt that they appreciably reduce the air quantity.

B. START-UP

1. START FAN AND CHECK ROTATION

Rotation MUST correspond to the directional arrows provided.

2. ADJUST OPTIONAL HI-LIMIT TO OPERATING POSITIONS

The hi-limit thermostat can be used for the protection of the equipment or the product against excessive temperatures when set properly.

Hi-limit thermostats of the non-indicating type (ones which do not show the temperature) can be properly set only after oven is in operation. Until then, such thermostats should be set at their maximum positions so all

preliminary testing and adjusting can be done. Before putting oven into production, adjust this type of thermostat as follows: Set the temperature control thermostat at 14°C (25°F) above the desired operating temperature. Operate oven until the control thermostat is regulating. Carefully adjust the hi-limit downward until it trips. Reset the temperature control thermostat at the desired operating temperature. The two instruments are now set in their correct positions.

NOTE: Never operate oven at a temperature in excess of the maximum operating temperature which is 204°C (400°F).

NOTE: All ovens are tested at the factory; however, shipping may cause damage or deviation. Therefore, before oven is put into regular service, the following items should be inspected and adjusted if necessary: thermostat calibration, doors, hinges, latches and other miscellaneous parts.

3. OPTIONAL PROCESS TIMER (SPRING WOUND)

Turn process timer to the desired time interval. The heater will shut off after the timer times out. Turn timer knob to hold position to eliminate the timer function.

C. OPERATION

1. KEEP EQUIPMENT CLEAN

Gradual dirt accumulation retards air flow. A dirty oven can result in unsatisfactory operation such as unbalanced temperatures in the work chamber, reduced heating capacity, reduced production, overheated components, etc.

Keep the walls, floor and ceiling of the oven work chamber free of dirt and dust. Floating dust or accumulated dirt may produce unsatisfactory results.

Keep all equipment accessible. Do not permit other materials to be stored or piled against it.

2. PROTECT CONTROLS AGAINST EXCESSIVE HEAT

This is particularly true of controls, motors or other equipment containing electronic components. Temperatures in excess of 51.5°C (125°F) should be avoided.

3. ESTABLISH MAINTENANCE AND CHECK-UP SCHEDULES

Do this promptly and follow them faithfully. Careful operation and maintenance will be more than paid for in continuous, safe and economical operation.

4. MAINTAIN EQUIPMENT IN GOOD REPAIR

Make repairs immediately. Delays may be costly in added expense for labor and materials and in prolonged shut down.

5. LUBRICATION

Fan motor bearings are permanently lubricated.

All door latches, hinges, door operating mechanisms, bearing or wear surfaces should be lubricated to ensure easy operation.

6. CHECK SAFETY CONTROLS

This should be done as indicated.

Make these tests carefully and do them regularly. The safety of personnel as well as the equipment may depend upon the proper operation of any one of these controls at any time.

a. TEMPERATURE CONTROL (40 hours)

Observe heater indicator light to insure that the heater is cycling on and off.

b. OPTIONAL HI-LIMIT (40 hours)

With the oven operating at a given temperature, gradually turn the hi-limit control knob down to the set point operating temperature. The hi-limit is in control when the heater indicator light shuts off.

IMPORTANT

WARNING: Failure to heed these restrictions can result in property damage, serious bodily injury or death.

THE USER(S) OF THIS EQUIPMENT MUST COMPLY WITH OPERATING PROCEDURES AND TRAINING OF OPERATING PERSONNEL AS STATED IN THE OCCUPATIONAL SAFETY AND HEALTH ACT (OSHA) of 1970, SECTION 5, AND THE NATIONAL FIRE PROTECTION ASSOCIATION (NFPA) 86A of 1973 (ARTICLE 100, SECTION 2d, 5 AND APPENDIX 1).

DO NOT use any flammable solvent or other flammable materials or enclosed containers in the oven.

DO NOT attempt any service on this equipment without first disconnecting the main power switch or power cord.

DO NOT exceed the maximum operating temperature, 204°C (400°F).

DO NOT use oven in wet, corrosive or explosive atmosphere.

REPLACE 3F fuses with NON-6 or OT-6 (250V, 6 AMP) only.

FOR supply connections on LDB 1-69 (240V) use 14 AWG or larger wires; LDB 2-18 use 12 AWG or larger wires; and LDB 2-27 and LDB1-69 (120V) use 10 AWG or larger wires. All wires must be suitable for at least 75°C (167°F).

Operation

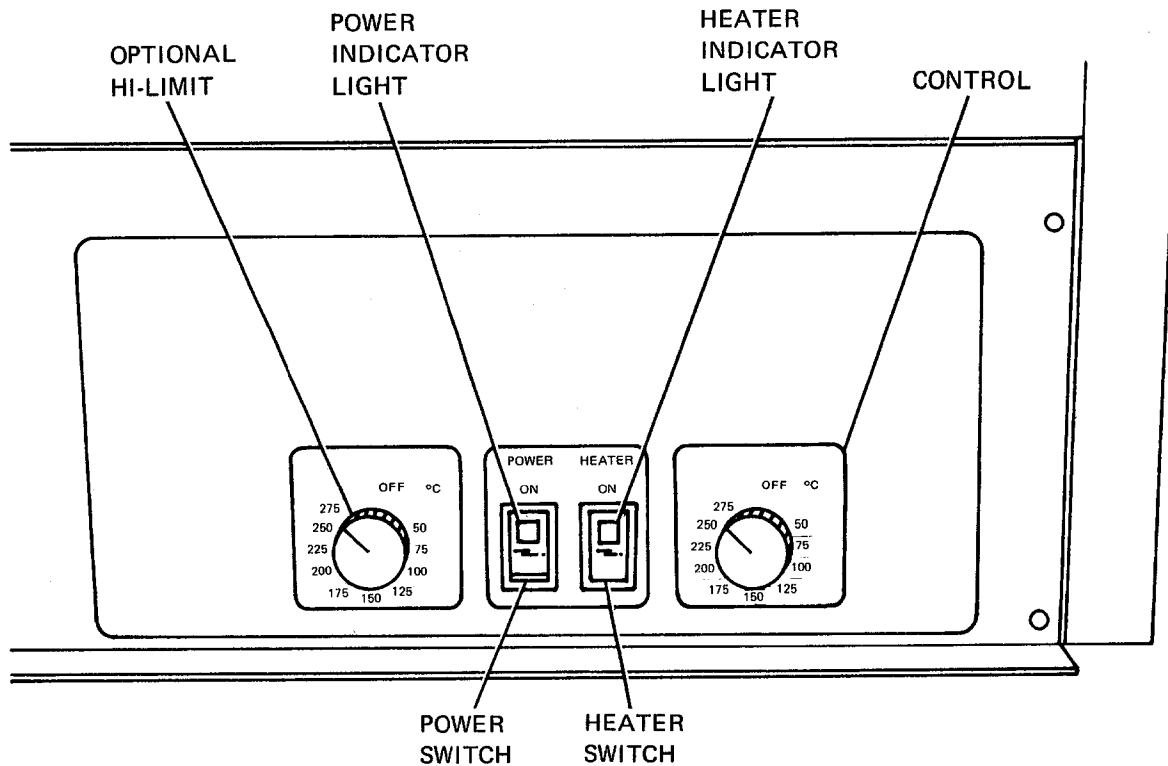

7. VENTILATION

There is a small fresh air opening in the bottom of the unit that is always open. The exhaust can be adjusted open or closed by lining up the openings in the rotating part of the vent mechanism on the top of the oven.

8. PRACTICE SAFETY

Make it a prime policy to "know what you are doing before you do it." Make **CAREFULNESS, PATIENCE** and **GOOD JUDGEMENT** the safety watchwords for the operation of your oven.

Starting the Oven

1. Push power switch to "ON" (indicator light should light). This activates the fans and control circuit.
2. Set temperature control to desired operating temperature by dialing the knob. **Do not** exceed 204°C (400°F). Although the control dial will turn to 275°C, the oven is **not** designed to operate above 204°C.
3. Turn heater switch to "on" (indicator light in rocker switch should light). This activates the heating elements. When desired temperature is reached, temperature control device will turn off and on to maintain temperature and heater switch indicator light will turn on and off accordingly.
4. Set optional hi-limit device by rotating hi-limit control knob to 10-15°C (18-27°F) above process temperature. Set point should be low enough to prevent damage to the workload but high enough to allow the thermostat to control at set point. Hi-limit will assume control of heater if chamber temperature exceeds high limit set point.

For fastest oven heat-up time, close the top vent, which is adjustable for varying degrees of ventilation. After desired temperature is reached, vent may be adjusted as needed. Examples: 1) for drying operations, open vent to prevent buildup of moisture within the oven; 2) for sample heating, close the vent when no ventilation is required.

When operating temperature is near 65°C, the vent(s) should be wide open.

Loading the Oven

1. Avoid spills of anything onto the heater elements or floor of oven.
2. The two shelves are designed to be pulled out about half-way without tipping.
3. The support capacity of the shelves is 25 pounds. Do not overload the shelves.
4. Do not place the load on the oven floor plate. Placing the load on the oven floor plate may cause the load to heat unevenly and the weight may cause shorting out of the heater elements. Use the shelves provided.
5. Distribute workload evenly so that airflow is not restricted.
6. Do not overfill your oven. The workload should not take up more than two-thirds of any dimension of the inside cavity.

Shutting down the oven

1. Push the heater switch to "OFF" after the heating cycle is complete.
2. Do not turn the power off until the oven temperature is below 150°C (302°F). If the oven is turned off before it is properly cooled, the fan shaft and motor bearings may become overheated, shortening the life of the motor.

WARNING — Disconnect main power switch or power cord before attempting any repairs or adjustments.

Replacing control unit or optional hi-limit (Tools needed: screwdriver)

- Remove perforated floor plate from oven interior by removing screws and sliding floor forward.
- Unclip control bulb from retainer clip.
- Turn oven on its back and remove bottom plate.
- Feed control bulb from inside of oven down into control compartment.
- Disconnect the two wires from the controller, noting the wire terminal locations. Remove knob from outside. Remove two screws under the decal holding controller unit to control panel. Remove control unit.
- To install new controller, attach screws onto control. Put on new square scale sticker. Replace knob. Replace the two wires to the same terminal from which you removed them.
- Extend capillary tube, being careful not to kink or crimp it. Carefully feed control bulb into oven chamber.
- Replace bottom and turn oven right side up.
- Clip new bulb into retainer clip.
- Replace interior floor and screws.

NOTE: The control has been calibrated at the factory but recalibration may be necessary. Refer to the section in this manual on recalibration.

Replacing heater unit (Tools needed: crescent wrench, screwdriver)

- Remove perforated floor plate by removing screws and sliding floor forward.
- Disconnect heater leads from heater element with wrench. Note which wires go on which terminals.
- Unscrew the screws holding the frame to the oven body. Remove the heater and discard.
- Screw down new heater frame.
- Attach heater leads to appropriate terminals.
- Replace interior floor and screws.

Replacing the fan motor (Tools needed: screwdriver, 1/8" Allen wrench)

- Remove perforated floor plate by removing screws and sliding floor forward.
- Loosen two set screws on fan wheel in middle of oven bottom by going through the heater or by disconnecting the heater and removing it to gain access.
- Turn oven on its back and remove bottom plate.
- Unscrew the four screws holding motor mounts to body.
- Remove motor. (Note: After fan wheel runs at temperature for awhile, it will stick to the shaft. Some force may be required to separate the two.)

- Disconnect motor leads from terminal strip on control panel.
- Take motor mounts off motor.
- Put motor mounts onto new motor.
- Reattach fan wheel to shaft by inserting shaft into shaft collar. (Put wheel onto shaft from inside of oven.)
- Reattach motor mounts to oven body making sure grommets are in place.
- Attach motor lead wires to terminal strip (See wiring diagram.)
- Replace oven bottom and turn oven right side up.
- Adjust fan wheel for 3/16" clearance between wheel and inlet ring.
- Tighten set screws. (Make sure set screws hit the flats machined onto the motor shaft.)
- If heater was removed, replace it.
- Replace interior floor and screws.

Recalibrating the temperature control device or optional hi-limit (Tools needed: small screwdriver)

NOTE: If oven temperature and control dial setting disagree by more than 25°, the control needs recalibration.

- Turn oven on and set controller at 100°C. It should be stabilized at temperature for about 1 hour before adjustments are made.
- Pull control knob off. Calibration screw is located in center of thermostat shaft. (See photo below.)
- 1/4 turn of the screw equals approximately 20°C. (See diagram.)
- If controller set point is **higher** than actual oven temperature, turn calibration screw counterclockwise. If set point is **lower** than actual temperature, turn screw clockwise.
- Replace knob on shaft.
- If readings do not coincide within 30 minutes, repeat operation.

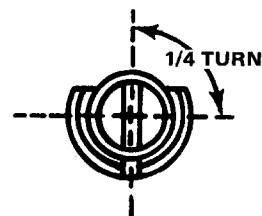
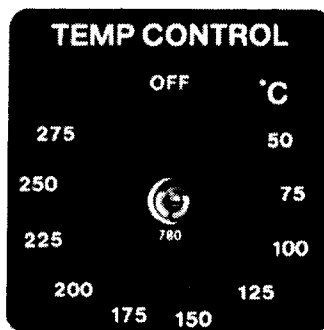

(This page is purposely left blank.)

Troubleshooting

Any equipment operating for as many hours a day as lab ovens often do is likely to have problems now and then. Below are possible problems and suggested solutions. If you have a problem not listed and don't know what to do, contact Despatch at our toll free "Help Line" 800-328-5476 (In MN 800-462-5396).

DIFFICULTY	PROBABLE CAUSE	SUGGESTED REMEDY
Failure to heat	No power	Check power source and/or oven and wall fuses
	Broken or frayed cord	Replace with new cord and plug set
	Burned out heating element	Replace element (see warranty statement, back page)
	Control malfunction	Replace controller
Slow heat up	Loose wire connections	Disconnect power and check connections behind control panel
	Improperly loaded	Reduce load or redistribute load in chamber
	Low line voltage	Supply sufficient power and proper connections. Check to see if circuit is overloaded
	1 or 2 heating elements are burned out	Replace burned out element (see warranty statement, back page)
	240 volt oven is connected to a 208 volt line	Raise line voltage
Frequent heater element burn out	Fan motor failure	Replace fan motor
	Harmful fumes generated by load	Increase vent opening or discontinue process
	Spillage or splattering of material on heating elements	Disconnect power and clean oven chamber and elements
Erratic temperatures	Overheating oven	Do not operate over 204°C (400°F)
	Control malfunction	Replace control unit
Inaccurate temperatures	Control miscalibration	Recalibrate control (see section on control recalibration)
	Optional Hi-limit setting	Hi-limit should be 10-25° higher than control set point
Excess surface temperature on door	Door seal deterioration	Replace door seal
Improper airflow	Fan motor failure	Replace fan motor
	Unbalanced fan wheel	Replace fan wheel
Excessive Vibration	Dirty fan wheel	Clean Fan
	Unbalanced fan wheel	Replace fan wheel
Oven will not control at set point	Hi-limit set too low	Set the hi-limit higher
	Hi-limit is out of calibration	Recalibrate the hi-limit (see directions on recalibrating the hi-limit)
	Control malfunction	Replace control
	Air friction of recirculation fan	Open exhaust air vent. Unit will not control below room ambient plus 45°C (81°F) with vent closed.
Heater does not shut off until the temperature reaches the hi-limit setting	Control malfunction	Replace control
	Relay malfunction	Replace relay

How to install LDB optional accessories.

Six optional accessories are available for LDB series ovens. They are available at any time from Despatch Industries' Customer Service Department, 612/331-1873.

When you order accessories, full instructions for mounting them in the control panel will be enclosed; however, in case they are misplaced, instructions are repeated here.

Process timers. Available for 60 minute or 6 hour cycles, these timers are electrically connected into oven control and will shut off the heater at end of cycle. (Tools needed: screwdriver, utility knife.)

- Disconnect power and remove control panel.
- From back of panel, locate pre-punched holes. Process timer can be mounted in either of the two far left sets of holes. From the front of panel, use utility knife to cut holes in the silver overlay.
- Put shaft and mounting screws through holes and screw timer into place.
- Remove one of the connectors (see photo) on back of control panel and replace it with the wired connector from the timer. (Connector is keyed to fit only one way.)
- Replace control panel.
- Peel top part of backing off black "Process Timer" sticker and apply it to front of control panel, using the two locating marks and shaft holes as location guides. Peel remaining backing off and smooth sticker down.
- Push knob onto shaft.



Signal Timer. This timer sounds an audible bell at the end of the cycle, up to 60 minutes. It is **not** electrically connected to oven and does **not** shut off heater. (Tools needed: screwdriver, utility knife.)

- Disconnect power and remove control panel.
- From back of panel, locate pre-punched holes. Signal timer can be mounted in either of the two far left sets of holes. From the front of panel, use utility knife to cut holes in the silver overlay.
- Put shaft and mounting screws through the holes and screw timer into place.
- Replace control panel.
- Peel top part of backing off black "Signal Timer" sticker and apply it to front of control panel, using the two locating marks and shaft hole as location guides. Peel remaining backing and smooth sticker down.
- Push knob onto shaft.

Over-temperature protection device (hi-limit). This controlling hi-limit is variably settable to 204°C. Should oven temperature exceed hi-limit set point, due to heater or controller malfunction, the device will assume control to keep temperature at proper level, protecting your load and the oven. (Tools needed: screwdriver, utility knife.)

- Disconnect power and remove control panel.

- From back of control panel, locate pre-punched holes. Hi-limit may be mounted in either of the two far left sets of holes. From the front of panel, use utility knife to cut holes in the silver overlay.
- Put shaft and mounting screws through holes and screw device into place, taking care that wire terminals are facing upwards.
- Replace control panel.
- Peel top part of backing off black "High Limit" sticker and apply it to front of control panel, using the two locating marks and shaft hole as location guides. Peel remaining backing and smooth sticker down.
- Push knob onto shaft.
- Remove floor plate from inside of oven.
- Tip oven on its back and remove bottom.
- Carefully uncoil capillary tube (see photo) taking care not to kink it. Feed capillary up from the bottom into oven chamber and clip it into bulb mounting clips. Note that temperature control bulb is already clipped into half of the double clip.

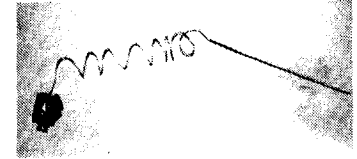

The end of the capillary tube closest to the hi-limit body is electrically insulated, but be sure that the uncoiled portion of the tube is **not** near any wire terminals.

- Replace oven bottom. Tip oven right side up. Replace chamber floor.
- To operate hi-limit, set knob at **maximum** desired temperature.

Pyrometer. Scaled in both °C and °F, this pyrometer indicates actual oven temperature. (Tools needed: adjustable wrench, hammer, utility knife.)

- Disconnect power and remove control panel.
- Locate pre-punched knock-out on back of panel. Pyrometer can be mounted only in the position immediately left of the power switch. Using knock-out lines as guides, cut hole in silver overlay with utility knife.
- Punch out knock-out, tapping gently with hammer.
- Put pyrometer into hole and screw into place.
- Replace control panel.
- Remove oven floor. Tip oven on its back and remove oven bottom.
- Feed pyrometer thermocouple from bottom into oven chamber and attach by twisting around control bulb (see photo). Be sure that the junction (tip end) is not touching metal.
- Replace bottom. Tip right side up. Replace oven floor.

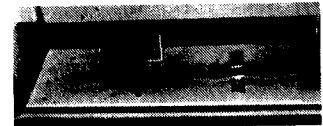

When replacing parts on your oven be sure you obtain the proper item by ordering genuine Despatch parts from your nearest Despatch dealer or from our Customer Service Department, 612/331-1873.

Industrial Equipment Commercial Warranty

Despatch Industries, Inc. warrants equipment manufactured by Despatch Industries, Inc., to be free from defects in workmanship and materials under normal use and service for a period of one (1) year from the date of delivery or the period of twenty-one hundred (2100) accumulated hours of use, whichever period is shorter.

Warranty on heating elements varies. Most oven heaters are warranted for five (5) years from date of delivery. See specific model description for element warranty. Life of furnace heating elements is affected to a large degree by overheating or failure due to contamination. Furnace elements are warranted only against manufacturing defects and a single sample element must be returned to the factory if a defect is claimed. When failure of elements is caused by a factory defect, credit for replacement elements provided in interim will be issued.

Components manufactured by others, including but not limited to expendable items, are excluded from this warranty and are warranted (if at all) only in accordance with the warranty, if any, issued by such other manufacturer.

Use or service with corrosive or abrasive chemicals or materials is not deemed normal.

If Purchaser gives written notice specifying the particular defect or defects within 14 days after discovery thereof, Despatch Industries, Inc. will correct without charge any workmanship that is demonstrated to Despatch Industries, Inc. satisfaction to have been defective at time of installation or erection and will repair or replace, at the warrantor's option, without charge, f.o.b. Despatch Industries, Inc. factory, parts covered by this warranty that upon inspection are found defective under normal use within the warranty period above stated.

All work of removal and reinstallation or installation of parts, whether or not found defective, and shipping charges for defective or replacement parts shall be at the sole expense of Purchaser.

The foregoing warranty shall not apply to equipment repaired or altered by others, unless such repairs or alterations were specifically agreed to in writing by an officer of Despatch Industries, Inc.

Despatch Industries, Inc. shall not be liable for incidental or consequential damages of any kind (whether for personal injury, lost profits or otherwise), whether arising from breach of this warranty, negligence or other tort or otherwise, which occur during the course of installation of equipment, or which result from the use or misuse by user, its employees or others of the equipment supplied hereunder, or from any malfunction or nonfunction of such equipment, and Purchaser's sole and exclusive remedy against Despatch Industries, Inc. for any breach of the foregoing warranty or otherwise shall be for the repair or replacement of the equipment or parts thereof affected.

The foregoing warranty shall be valid and binding upon Despatch Industries, Inc. if and only if user loads, operates and maintains the equipment supplied hereunder in accordance with the instruction manual to be provided upon delivery of the equipment.

Despatch Industries, Inc. does not guarantee the process of manufacture by user or the quality of product to be produced by the equipment supplied hereunder and Despatch Industries, Inc. shall not be liable for lost profits.

THE FOREGOING WARRANTY IS EXCLUSIVE AND IN LIEU OF ALL OTHER EXPRESS AND IMPLIED WARRANTIES AND REPRESENTATIONS WHATSOEVER, INCLUDING BUT NOT LIMITED TO THOSE OF MERCHANTABILITY OR OF FITNESS FOR A PARTICULAR PURPOSE.

LEB 1-21 & LEB 1-28 SCHEMATIC

LEBI-47

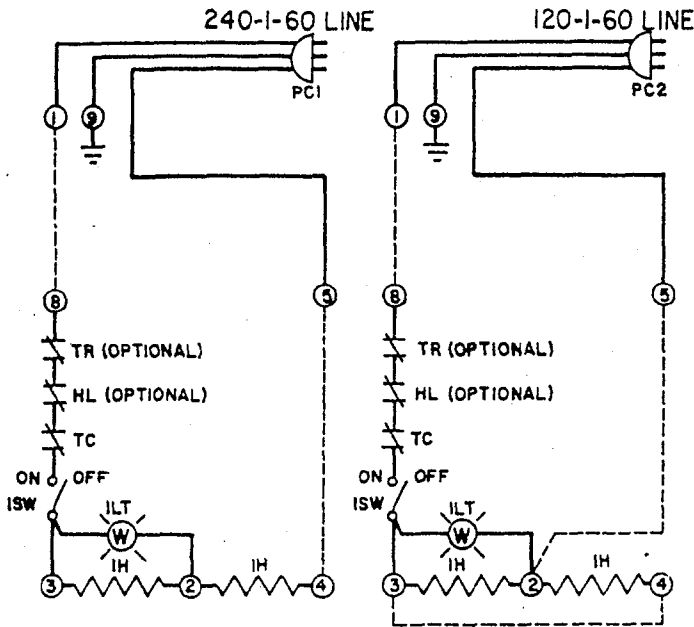

LDBI-17 & LDBI-24 SCHEMATIC

LDBI-43

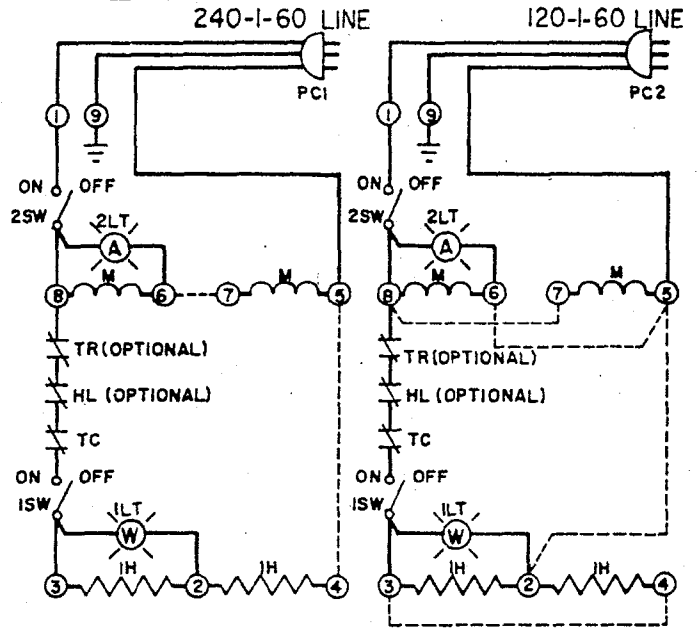

**LEBI-47
LEB 1-21 & LEB 1-28 WIRING DIAGRAM**

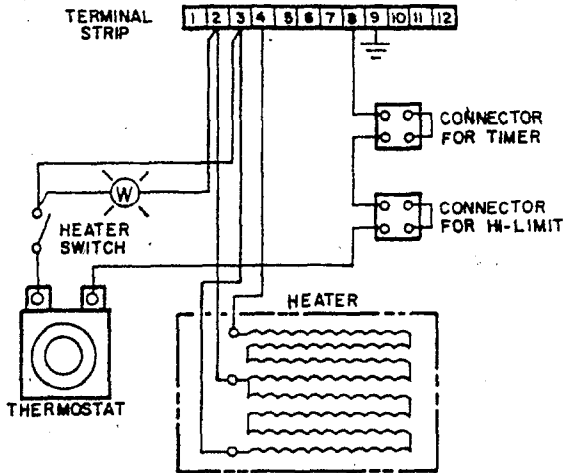

**LDBI-43
LDB 1-17 & LDBI-24 WIRING DIAGRAM**

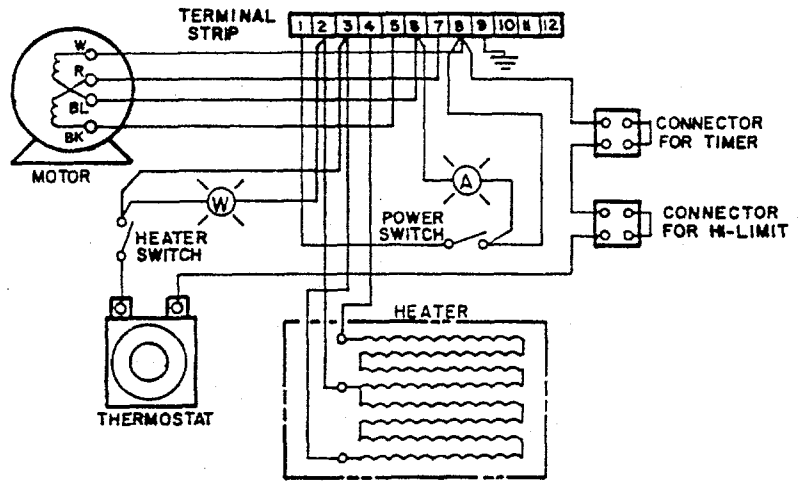

VOLTAGE	JUMPER	LDBI-17						LDBI-24						
		1	2	3	4	5	6	1	2	3	4	5	6	
120*	3 & 4	X	X	X	X	X	X	X	X	X	X	X	X	X
	1 & 8							X	X	X	X	X	X	X
	2 & 5	X	X	X	X	X	X	X	X	X	X	X	X	X
	7 & 8	X	X	X	X	X	X							
240*	5 & 6	X	X	X	X									
	4 & 5	X	X	X	X	X	X	X	X	X	X	X	X	X
	6 & 7	X	X	X	X									
	1 & 8							X	X	X	X	X	X	X

*NOTE: USE CORRECT CORD FOR PROPER VOLTAGE.

MATERIAL LIST	
IH - HEATER, 1200 WATTS	
M - MOTOR	
PCI - 240 VOLT POWER CORD	
PC2 - 120 VOLT POWER CORD	
ISW & ILT - HEATER SWITCH	
2SW & 2LT - POWER SWITCH	
TC - THERMOSTAT	
HL - HI-LIMIT	
TR - TIMER	

- NOTES**
- JUMPER
 - TERMINAL STRIP NUMBER

REV
11-22-82/TN/ADDED LDBI-43 & LEBI-47

THE DESIGN SHOWN ON THIS DRAWING IS THE EXCLUSIVE PROPERTY OF DESPATCH OVEN COMPANY AND IS SUBMITTED WITH THE UNDERSTANDING THAT IT IS NOT TO BE USED FOR ANY PURPOSE OR ITS CONTENTS DISCLOSED WITHOUT THE WRITTEN CONSENT OF DESPATCH OVEN COMPANY.

CUST. NO.	
SERIAL NO.	
DESPATCH OVEN COMPANY	
MINNEAPOLIS, MINNESOTA	
SCHEMATIC & WIRING DIAGRAM	
DESIGNED FOR	

ENGINEER	MD	SCALE	1/4" = 1" FT.	DATE	2-28-78
CHECKED					
APPROVED					
BE-7416					

Material List

LEB1-21, LEB1-28, LEB1-47, LDB1-17, LDB1-24, LDB1-43

Item	Part Number	Description
1H	007818	1200 Watt Heater 120/240V
	054353	1600 Watt Heater 120/240V <i>(LDB1-43 & LEB1-47 MODELS ONLY)</i>
M	205692	Motor Kit <i>(LDB MODELS ONLY)</i>
PC1	N/A	PC1 Power Cord
PC2	N/A	PC2 Power Cord
1SW & 1LT	074183	Heater Switch and White Light
2SW & 2LT	074182	Power Switch and Amber Light
TC	012383	B-10 Thermostat
HL	097356	Hi-limit Kit
TR	105068	6 Hour Process Timer Kit (Spring Wound)
	105069	1 Hour Process Timer Kit (Spring Wound)
	105070	12 Hour Process Timer Kit (Spring Wound)
Seal	018663	Door Seal
	010572	Pop Rivets
Latch	008199	Latch Adjustable

LDB I-69 SCHEMATIC

LEB I-76 SCHEMATIC

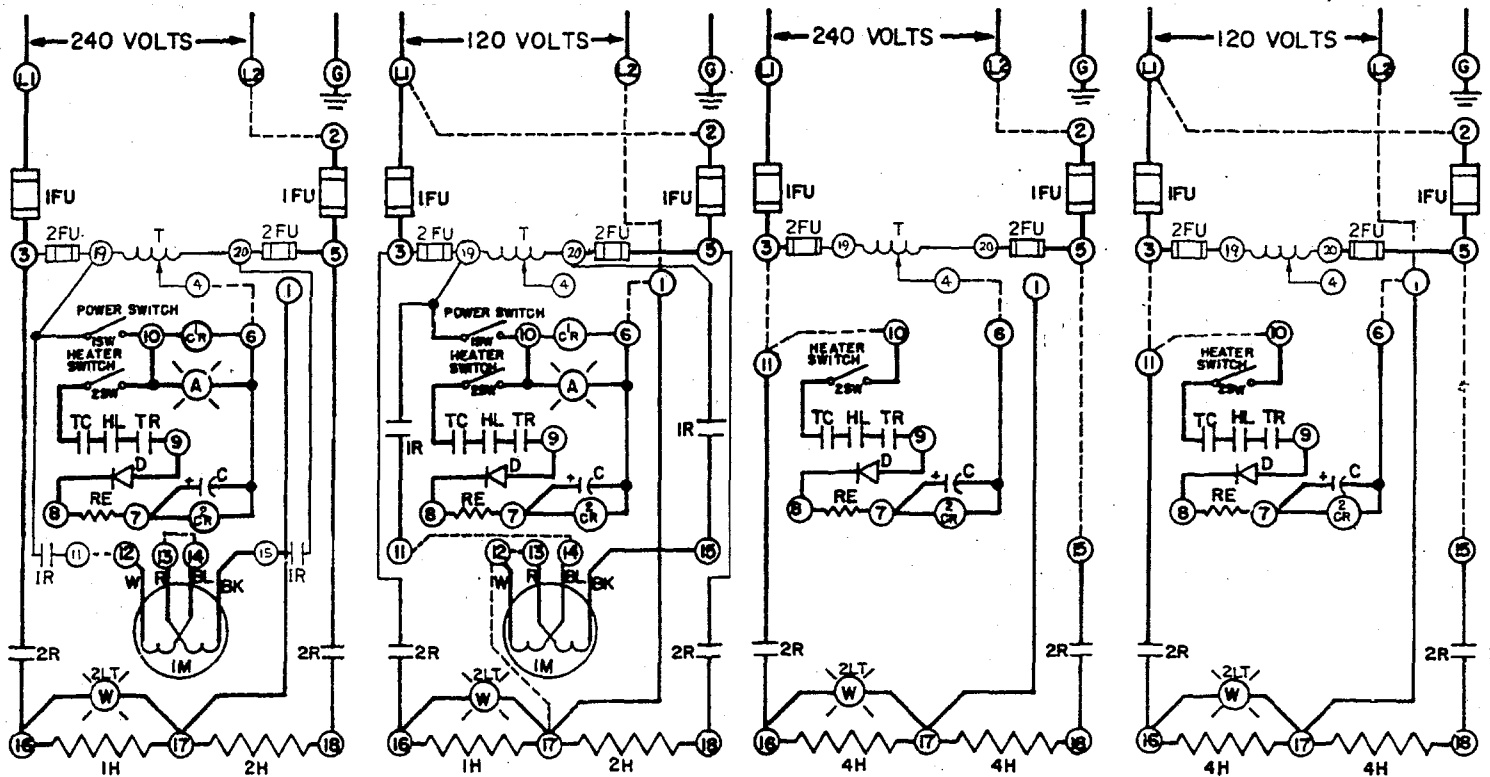

WIRING DIAGRAM

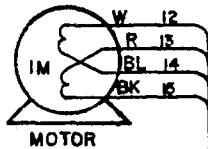

MOTOR

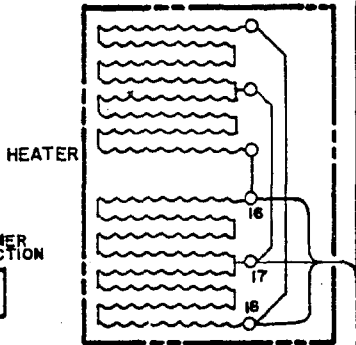

HEATER

CUSTOMER CONNECTION



VOLTAGE	JUMPER	LDB I-69	LEB I-76
120	L1 & 2	X	X
	L2 & 1	X	X
	1 & 6	X	X
	11 & 14	X	
	12 & 17	X	
	12 & 13	X	
	3 & 11		X
	5 & 15		X
	10 & 11		X
	10 & 12		X
240	L2 & 2	X	X
	4 & 6	X	X
	13 & 14	X	
	11 & 12		X
	5 & 15		X

NOTES

- JUMPER
- TERMINALS
- * POWER RELAY LDB I-69 ONLY

NO.	DATE	BY	AUTHOR	CHANGE
REVISIONS				

MATERIAL LIST

IFU-250V 15 AMP
T-AUTO TRANSFORMER
1S W & 1LT - POWER SWITCH
2S W & 2LT - HEATER SWITCH
IR- RELAY AC COIL *
2R- RELAY DC COIL
C- CAPACITOR
RE- RESISTOR
D- DIODE
TC- THERMOSTAT
HL- H-LIMIT
TR- TIMER
M- MOTOR
1-2H - HEATER, 1200 WATTS
4H - HEATER, 2400 WATTS
2FU- 250V 6 AMP

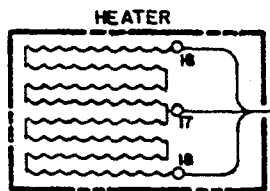

HEATER

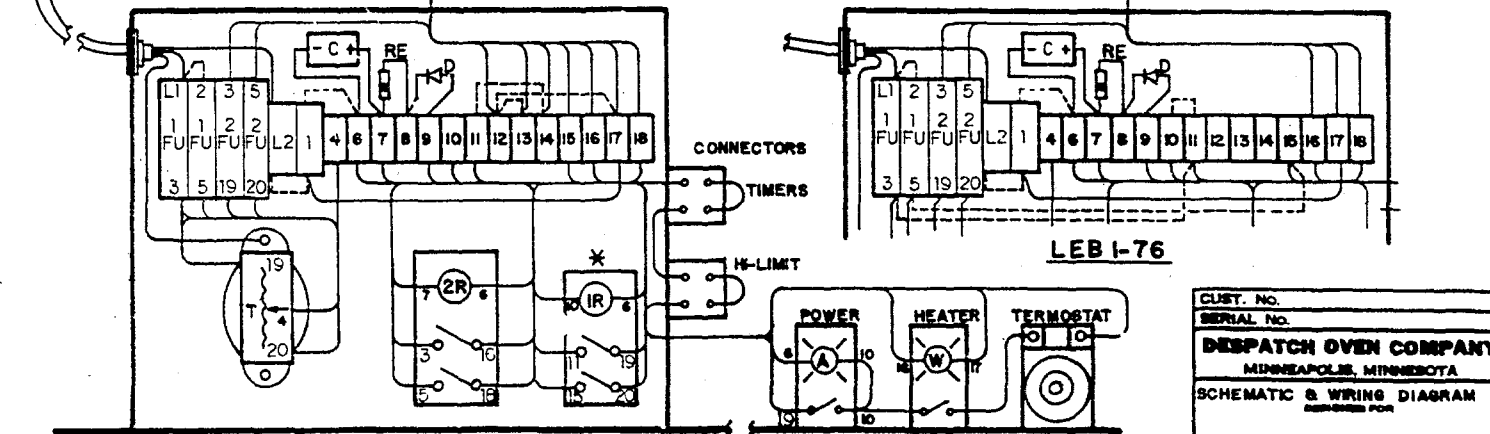

LDB I-69

LEB I-76

CUST. NO.
SERIAL NO.
DISPATCH OVEN COMPANY
MIDNEAPOLIS, MINNESOTA
SCHEMATIC & WIRING DIAGRAM
DESIGNED FOR

Material List

LEB1-76, LDB1-69

Item	Part Number	Description
1FU	007471	Fuse Block 30 Amp 250V
	007617	Fuse 30 Amp 250V
2FU	007471	Fuse Block 30 Amp 250V
	007436	Fuse 6 Amp 250V
T	012479	Transformer 50VA
1SW & 1LT	074183	Heater Switch and White Light
2SW & 2LT	074182	Power Switch and Amber Light
1R	010434	Relay Backup 120VAC
2R	010435	Relay Control 110VDC
C	004903	Capacitor 300 MFD 150WVDC
RE	010470	Resistor 1K ohm 5W
D	010398	Diode IN5060
TC	012383	B-10 Thermostat
HL	097356	Hi-limit Kit
TR	105068	6 Hour Process Timer Kit (Spring Wound)
	105069	1 Hour Process Timer Kit (Spring Wound)
	105070	12 Hour Process Timer Kit (Spring Wound)
M	205692	Motor Kit (LDB MODELS ONLY)
1-2H	007818	1200 Watt Heater 120/240V
4H	007819	2400 Watt Heater 120/240V
Seal	018663	Door Seal
	010572	Pop Rivets
Latch	008199	Latch Adjustable

LDB 2-18

SCHEMATIC

LDB 2-27

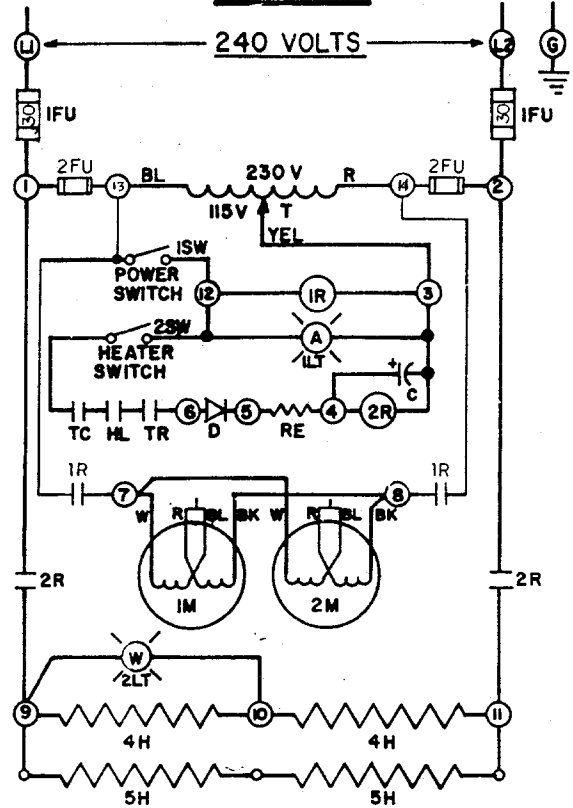
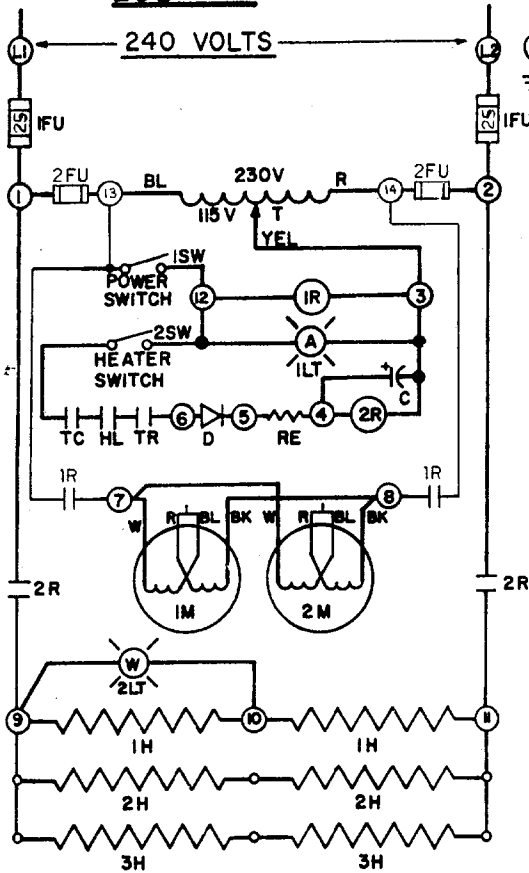

WIRING DIAGRAM

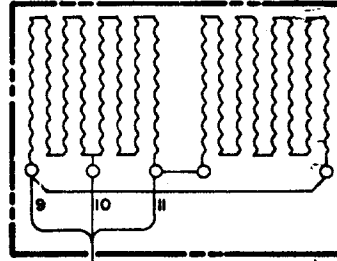
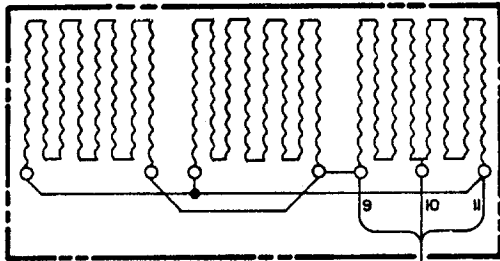
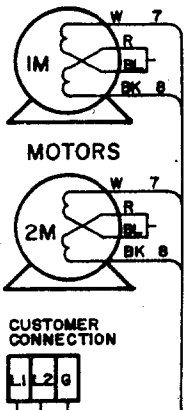

MATERIAL LIST	
IFU	- FUSES
T	- AUTO TRANSFORMER
ISW & ILT	- POWER SWITCH
2SW & 2LT	- HEATER SWITCH
IR	- RELAY 120V AC COIL
2R	- RELAY 120V DC COIL
C	- CAPACITOR
RE	- RESISTOR
D	- DIODE
TC	- THERMOSTAT
HL	- H-LIMIT
TR	- TIMER
1-2M	- MOTORS
1-3H	- HEATER, 1200 WATTS
4-5H	- HEATER, 2400 WATTS
2FU	250V 6AMP

NOTE:
○ TERMINAL NUMBER

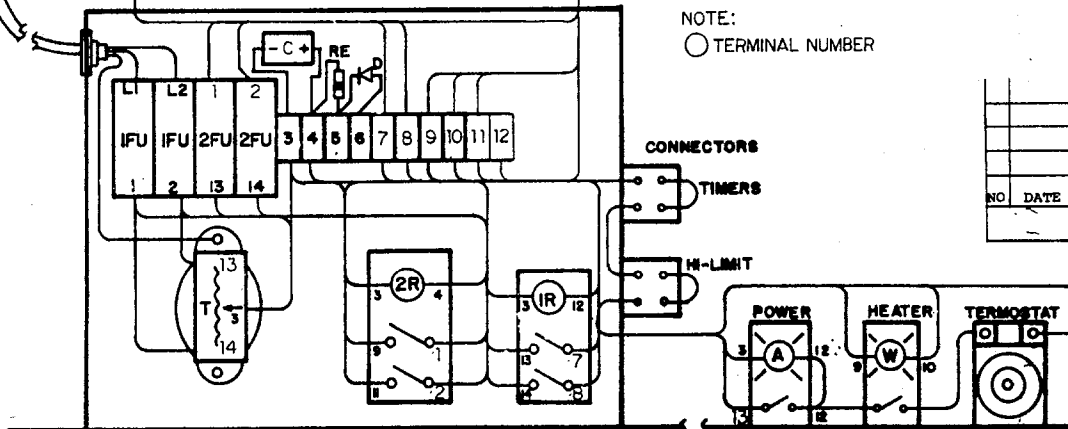

NO	DATE	BY	AUTHOR	CHANGE

REVISIONS

CLMT. NO.	
SERIAL NO.	
DESPATCH OVEN COMPANY	
MINNEAPOLIS, MINNESOTA	
SCHEMATIC & WIRING DIAGRAM	

THE DESIGN SHOWN ON THIS DRAWING IS THE EXCLUSIVE PROPERTY OF DESPATCH OVEN COMPANY AND IS SUBMITTED WITH THE UNDERSTANDING THAT IT IS NOT TO BE USED FOR ANY PURPOSE OR ITS CONTENTS DISCLOSED WITHOUT THE WRITTEN CONSENT OF DESPATCH OVEN COMPANY.

ENGINEER: [] SCALE: 1/1" = 1" DATE: 6-23-78
 CHECKED: []
 APPROVED: [] **BE-7416-2D**

Material List

LEB2-20, LEB2-30, LDB2-18, LDB2-27,

Item	Part Number	Description
1FU	007471	Fuse Block 30 Amp 250V
	007615	Fuse 25 Amp 250V (<i>LEB2-20 & LDB2-18 ONLY</i>)
	007617	Fuse 30 Amp 250V (<i>LEB2-30 & LDB2-27 ONLY</i>)
2FU	007471	Fuse Block 30 Amp 250V
	007436	Fuse 6 Amp 250V
T	012479	Transformer 50VA
1SW & 1LT	074183	Heater Switch and White Light
2SW & 2LT	074182	Power Switch and Amber Light
1R	010434	Relay Backup 120VAC
2R	010435	Relay Control 110VDC
C	004903	Capacitor 300 MFD 150WVDC
RE	010470	Resistor 1K ohm 5W
D	010398	Diode IN5060
TC	012383	B-10 Thermostat
HL	097356	Hi-limit Kit
TR	105068	6 Hour Process Timer Kit (Spring Wound)
	105069	1 Hour Process Timer Kit (Spring Wound)
	105070	12 Hour Process Timer Kit (Spring Wound)
1-2M	205692	Motor Kit (<i>LDB MODELS ONLY</i>)
1-3H	007818	1200 Watt Heater 120/240V
4-5H	007819	2400 Watt Heater 120/240V
Seal	018663	Door Seal
	010572	Pop Rivets
Latch	008199	Latch Adjustable